

# Hybrid Solar Charge Inverter

## Product Manual

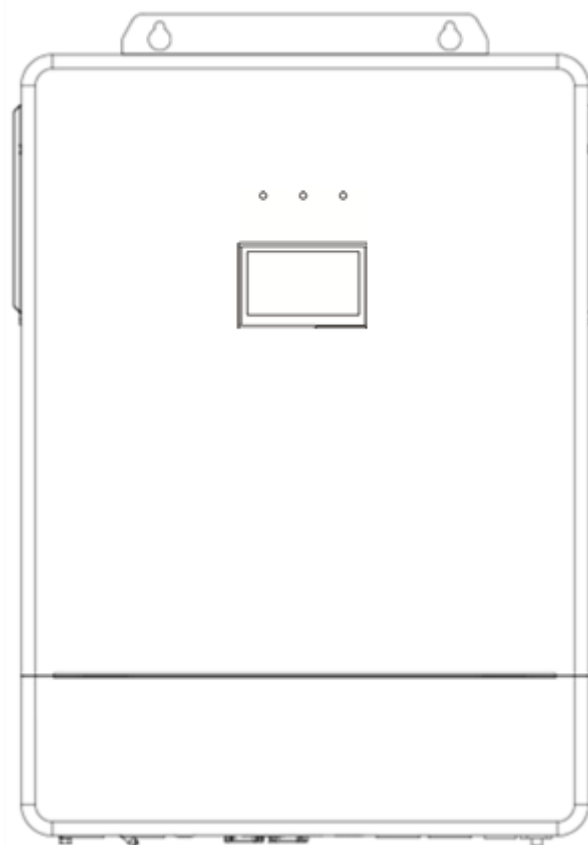

**AS103048-M200-A**

**AS123048-M220-A**

**AS103048-M200-B**

**AS123048-M220-B**

## Contents

1. Information on this manual .....	1
1.1、Scope .....	1
1.2、Target Group .....	1
1.3、Safety Instructions .....	1
1.4、Introduction .....	2
1.5、Product Features .....	3
2. Product Overview .....	5
3. Installation .....	6
3.1、Unpacking and Inspection .....	6
3.2、Preparation .....	6
3.3、Mounting the Unit .....	6
3.4、Lead-acid Battery Connection .....	7
3.5、Lithium Battery Connection .....	8
3.6、Lithium battery communication and setting .....	9
3.7、LCD setting .....	10
3.8、Communicating with battery BMS in parallel system .....	11
3.9、AC Input/Output Connection .....	11
3.10、PV Connection .....	13
3.11、Final Assembly .....	15
3.12、Starting inverter .....	15
4. Operation .....	16
4.1、Power ON/OFF .....	16
4.2、Operation and Display Panel .....	16
4.3、Setup parameters description .....	17
5. Operating Mode Description .....	26
5.1、Charging mode .....	26
5.2、AC output mode .....	27
6. Battery type parameters .....	29
6.1、For Lead-acid Battery .....	29
6.2、For Lithium Batter .....	30
7. Communication .....	32
7.1、Overview .....	32
7.2、USB communication port .....	32
7.3、RS485 communication port .....	32
7.4、Dry contact port .....	34
7.5、CT sampling detection (anti feed-in) .....	34
7.6、Parallel communication function (parallel operation only) .....	34
8. Parallel installation and wiring .....	36
8.1、Introduction .....	36
8.2、Precautions for connecting the parallel connecting lines .....	36
8.3、Schematic diagram of parallel connection in single phase .....	39
9. Failure codes and countermeasures .....	43
9.1、Fault code .....	43
9.2、Trouble Shooting .....	47
10. Protection and Maintenance .....	49

10.1、 Protections provided .....	49
10.2、 Maintenance .....	51
11. Technical parameters .....	52

# 1. Information on this manual

This manual describes the assembly, installation, operation and troubleshooting of this unit. Please read this manual carefully before installations and operations. Please keep this manual for future use.

## 1.1. Scope

This manual provides safety and installation guidance as well as information about tools and wiring.

## 1.2. Target Group

This document is intended for qualified persons and end users. Tasks that do not require any particular qualification can also be performed by end users. Qualified persons must have the following skills:

- 1、 Knowledge of how an inverter works and was operated.
- 2、 Training in how to deal with the dangers and risks associated with installing and using electrical devices and installations.
- 3、 Training in the installation and commissioning of electrical devices and installations.
- 4、 Knowledge of the applicable standards and directives.
- 5、 Knowledge of and compliance with this document and all safety information.

## 1.3. Safety Instructions

- 1、 Before using the unit, read all instructions and cautionary marking on the unit, the batteries and all appropriate sections of this manual. The company has the right not to quality assurance, if not according to the instructions of this manual for installation and cause equipment damage.
- 2、 Please be clear which kind of battery system you want, lithium battery system or lead-acid battery system, if you choose the wrong system, energy storage system can't work normally.
- 3、 Do not disassemble the unit. Take it to a qualified service center when service or repair is required. Incorrect re-assembly may result in a risk of electric shock or fire.
- 4、 All the operation and connection please professional electrical or mechanical engineer. All the electrical installation must comply with the local electrical safety standards.
- 5、 **CAUTION-To** reduce risk of injury, charge only deep-cycle lead-acid type rechargeable batteries and lithium batteries. Other types of batteries may burst, causing personal injury and damage.
- 6、 To reduce risk of electric shock, disconnect all wirings before attempting any maintenance or

cleaning. Turning off the unit will not reduce this risk.

7. For optimum operation of this inverter, please follow required spec to select appropriate cable size. It's very important to correctly operate this inverter.
8. **GROUNDING INSTRUCTIONS** -This inverter should be connected to a permanent grounded wiring system. Be sure to comply with local requirements and regulation to install this inverter.
9. **NEVER** cause AC output and DC input short circuited. Do NOT connect to the mains when DC input short circuits.
10. Do not install the inverter in harsh environments such as moist, oily, flammable or explosive, or heavily dusty areas.
11. **Warning! !** Only qualified maintenance personnel can repair this equipment. If the fault persists after troubleshooting according to the troubleshooting table, take this inverter/charger back to your local dealer or service center for repair.
12. Do not reverse polarity of the battery input; otherwise, the device may be damaged or unpredictable risks may occur.
13. Make sure the inverter is completely assembled, before the operation.
14. Necessary to confirm that the inverter AC output power is the only input device for load, and it is forbidden to use it in parallel with other input AC power to avoid damage.
15. Recommended to attach proper fuse or circuit breaker to the outside of the inverter.

## 1.4. Introduction

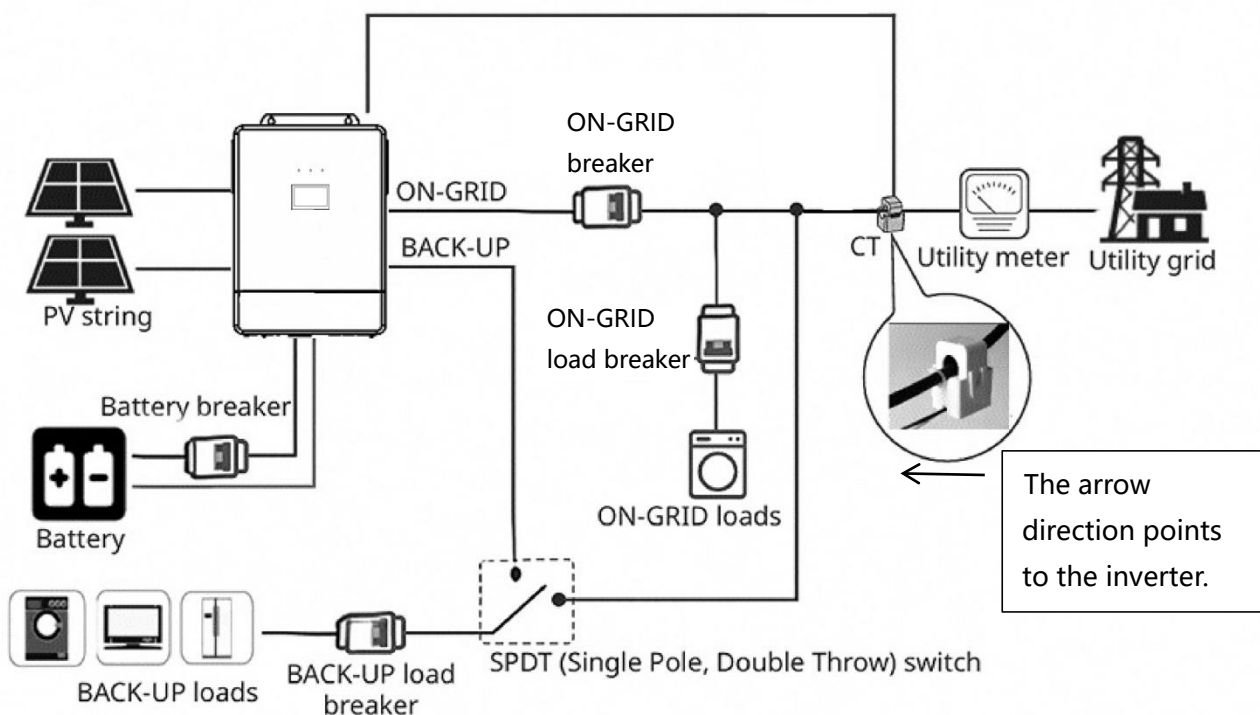

The figure below shows the system application scenario of this product. Specific system wiring method depends on the actual application scenario. A complete system consists of the following parts:

- 1、 **PV String:** convert light energy into DC power, and charge the battery through the inverter, or directly invert into AC power to drive the load.
- 2、 **Mains or generator:** connected at the AC input, to power the load while charging the battery. If the mains or generator is not connected, the system can also operate normally, and the load is powered by the battery and PV module.
- 3、 **Battery:** According to the energy storage and energy release function of the system requirements. Support lithium battery and lead acid battery (set setup).
- 4、 **Household load:** allow connection of various household and office loads, including refrigerators, lamps, TVs, fans and air conditioners.
- 5、 Hybrid solar charge inverter: the energy conversion unit of the whole system.
- 6、 WiFi or GPRS: can monitor system permissions remotely.
- 7、 **CT:**It is used to detect current.(Two CT's were placed on two fire lines, CT arrows point to the inverter).

## 1.5、 Product Features

- 1、 It has the function of sectional charge and discharge (can set the time period for battery charging or discharging).
- 2、 Allowing access of lead-acid battery and lithium battery.
- 3、 Anti feed-in, self-consumption function (can be hybrid power supply from solar, battery and grid).
- 4、 It can be used without battery. Solar and utility grid can power loads at the same time.
- 5、 With dual activation function of lithium battery. It can be triggered by any power supply of the mains or solar (when the li-ion battery was dormant).
- 6、 Power saving mode available to reduce no-load loss.
- 7、 Available in four charging modes: Only Solar, Mains Priority, Solar Priority and Mains & Solar hybrid charging.
- 8、 Two output modes: mains bypass and inverter output; Uninterrupted power supply.
- 9、 Complete protections, including over voltage and under voltage protection, overload protection, reverse protection, etc. 360° all-round protection with a number of protection functions.
- 10、 With touch resistance LCD screen dynamic flow diagram design, easy to understand the system data and operation status.
- 11、 Full digital voltage and current double closed loop control, advanced SPWM technology, output of pure sine wave; support split-phase and single-phase pure sine wave output; Supports five different voltage levels of 100Vac, 105Vac, 110Vac,120Vac ,127Vac per phase.

- 12、 Supports two independent MPPTs, advanced MPPT technology with a tracking efficiency of 99.9%.
- 13、 Intelligent variable speed fan to efficiently dissipate heat and extend system life.
- 14、 Diverse human-computer interaction: support CAN, USB, WiFi and RS485 communication, local and remote power on or off, dry contact control.
- 15、 Can be extended: external CT for whole house energy anti feed-in and self-consumption.

## 2. Product Overview

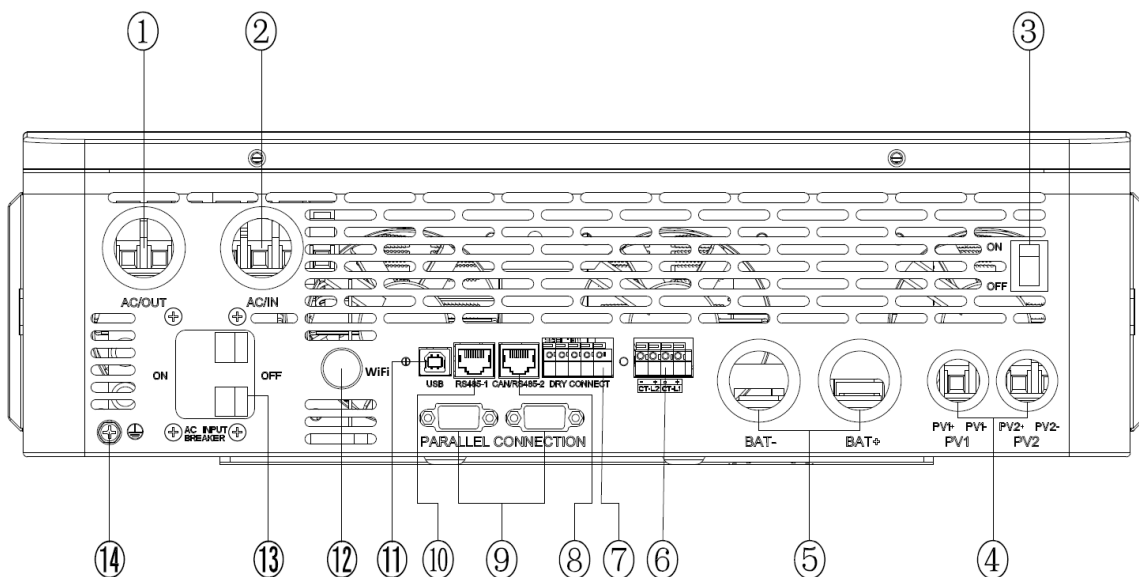
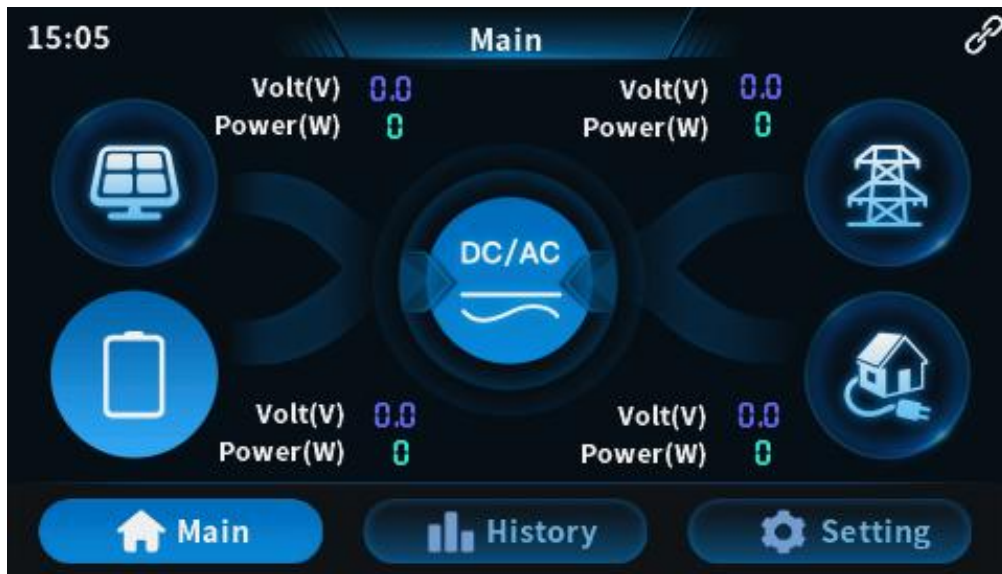

①	AC output port	⑧	RS485-2/CAN communication port
②	AC input port	⑨	Parallel communication port (parallel module only)
③	ON/OFF rocker switch	⑩	RS485-1 communication port
④	Photovoltaic (PV) parameters	⑪	USB communication port
⑤	Battery parameters	⑫	WiFi port (optional)
⑥	CT current sensing for self-consumption(optional)	⑬	AC input breaker
⑦	Dry contact port	⑭	Grounding screw hold

## 3. Installation

### 3.1. Unpacking and Inspection

Before installation, please inspect the unit. Be sure that nothing inside the package is damaged.

You should have received the following items in the package:

- ◆ The unit x 1
- ◆ User manual x 1
- ◆ Ring terminal x 2
- ◆ Expansion bolts x 2
- ◆ Expansion screws x 2

### 3.2. Preparation

Before connecting all wiring, please take off bottom cover by removing four screws as shown below.

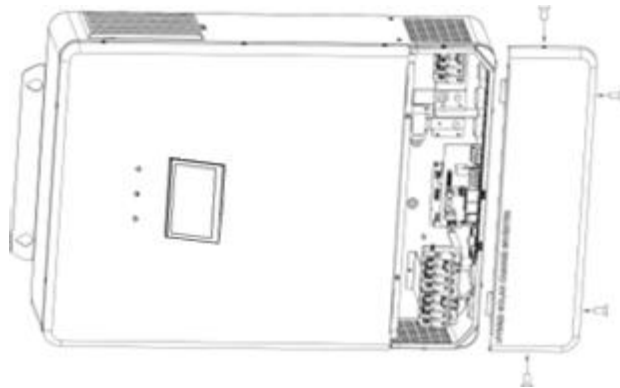

### 3.3. Mounting the Unit

Consider the following points before selecting where to install:

- Do not install the inverter on flammable building materials.
- Mount on a sturdy surface.
- Install this inverter at eye level in order to allow the LCD display to be read at all times.
- The ambient temperature should be between  $-10^{\circ}\text{C}$  and  $55^{\circ}\text{C}$  to ensure optimal operation.
- The recommended installation position is to be adhered to the wall vertically.
- Be sure to keep other objects and surfaces as shown in the right diagram to guarantee sufficient heat dissipation and to have enough space for removing wires.

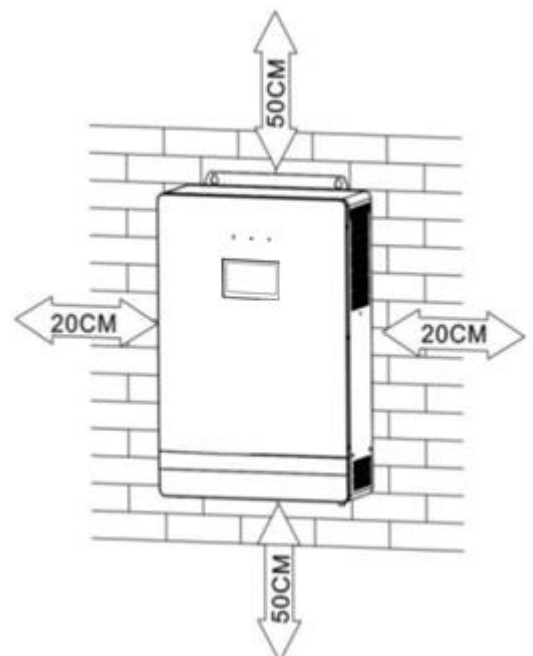

**SUITABLE FOR MOUNTING ON CONCRETE OR OTHER NON-COMBUSTIBLE SURFACE ONLY.**

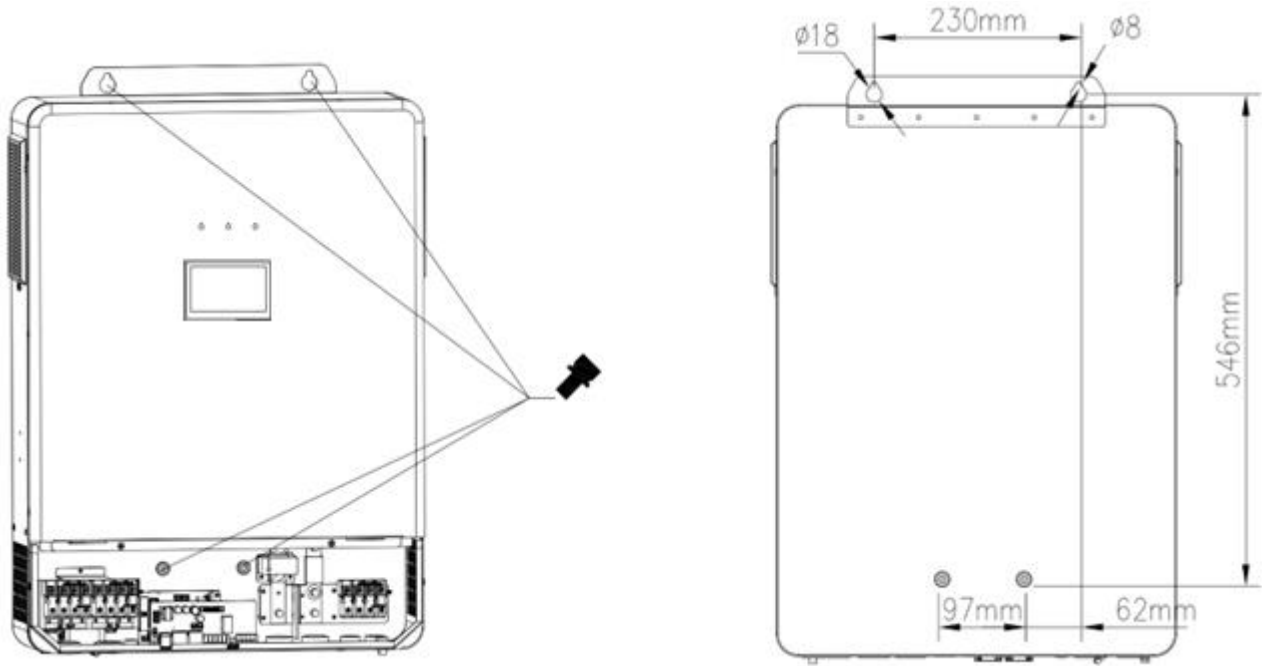

Install the unit by screwing four screws. It's recommended to use M4 or M5 screws.

### 3.4、 Lead-acid Battery Connection

User can choose proper capacity lead acid battery with a nominal voltage at 48V. Also, you need to choose battery type as "GEL (default) , SLD or FLD" .

**CAUTION:** For safety operation and regulation compliance, It's requested to install a separate DC over-current protector or disconnect device between battery and inverter. It may not be requested to have a disconnect device in some applications, however, It's still requested to have over-current protection installed. Please refer to typical amperage in below table as required fuse or breaker size.

#### Ring terminal:

**WARNING!** All wiring must be performed by a qualified person.

**WARNING!** It's very important for system safety and efficient operation to use appropriate cable for battery connection. To reduce risk of injury, please use the proper recommended cable and terminal size as below.

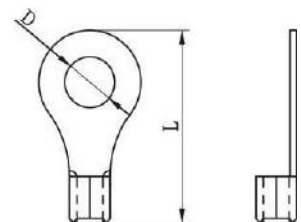

#### Recommended battery cable and terminal size:

Models	Wire Size	Rated battery discharge current	Maximum charging current	Recommended air switch or circuit breaker type	Torque value
AS123048-M220-A	67mm <sup>2</sup> /00AWG	270A	220A	2P—300A	2-3Nm
AS123048-M220-B	67mm <sup>2</sup> /00AWG	270A	220A	2P—300A	2-3Nm
AS103048-M200-A	53.5mm <sup>2</sup> /0AWG	220A	200A	2P—250A	2-3Nm
AS103048-M200-B	53.5mm <sup>2</sup> /0AWG	220A	200A	2P—250A	2-3Nm

**Note: For lead acid battery, the recommended charge current is 0.2C(C→battery capacity)**

Please follow below steps to implement battery connection:

- 1、 Assemble battery ring terminal based on recommended battery cable and terminal size.
- 2、 Connect all battery packs as units requires. It' s suggested to connect at least 200Ah capacity battery.
- 3、 Insert the ring terminal of battery cable flatly into battery connector of inverter and make sure the bolts are tightened with torque of 2Nm. Make sure polarity at both the battery and the inverter/charge is correctly connected and ring terminals are tightly screwed to the battery terminals.

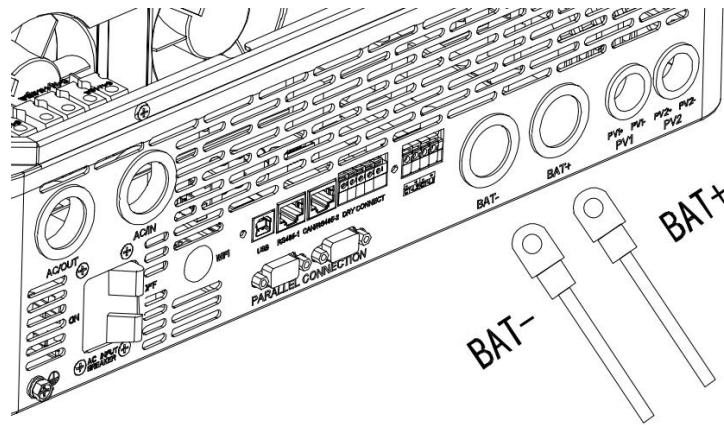

	<p><b>WARNING: Shock Hazard</b></p> <p>Installation must be performed with care due to high battery voltage in series.</p>
	<p><b>CAUTION!!</b> Do not place anything between the flat part of the inverter terminal and the ring terminal. Otherwise, overheating may occur.</p> <p><b>CAUTION!!</b> Do not apply anti-oxidant substance on the terminals before terminals are connected tightly.</p> <p><b>CAUTION!!</b> Before making the final DC connection or closing DC breaker/disconnector, be sure positive (+) must be connected to positive (+) and negative (-) must be connected to negative.</p>

### 3.5、 Lithium Battery Connection

If choosing lithium battery for this inverter, you are allowed to use the lithium battery only which we have configured. There're two connectors on the lithium battery, RJ45 port of BMS and power cable.

**Please follow below steps to implement lithium battery connection:**

- 1、 Assemble battery ring terminal based on recommended battery cable and terminal size (same as Lead acid, see section Lead-acid Battery connection for details).

- 2、 Insert the ring terminal of battery cable flatly into battery connector of inverter and make sure the bolts are tightened with torque of 2-3Nm. Make sure polarity at both the battery and the inverter/charge is correctly connected and ring terminals are tightly screwed to the battery terminals.
- 3、 Connect the end of RJ45 of battery to BMS communication port(RS485-2/CAN ) of inverter.
- 4、 The other end of RJ45 insert to battery communication port(RS485).

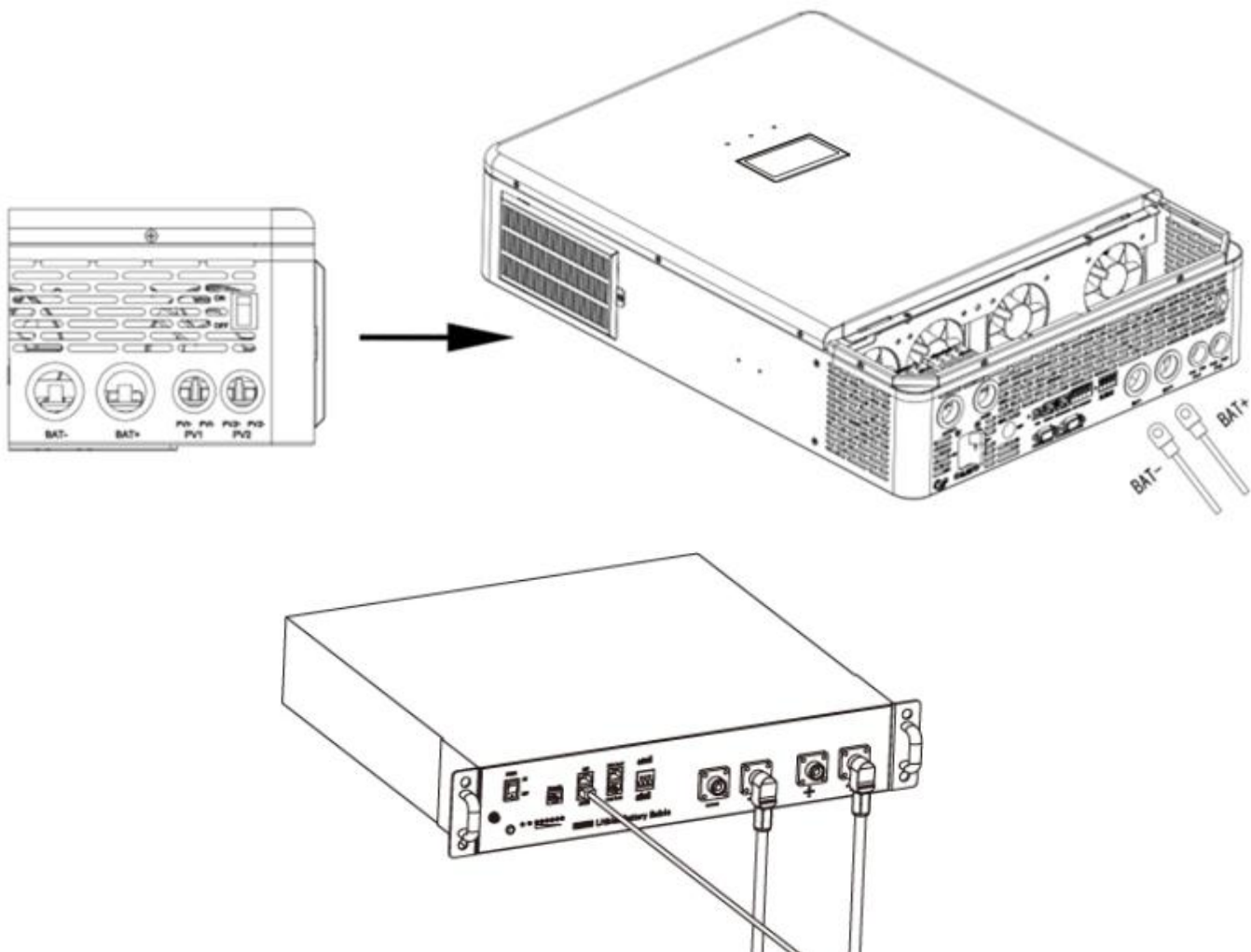

**Note:** If choosing lithium battery, make sure to connect the BMS communication cable between the battery and the inverter. See Section 3.7 for other Settings.

### 3.6、 Lithium battery communication and setting

Connect the end of RJ45 of battery to BMS communication port of inverter.

Make sure the lithium battery BMS port connects to the inverter is Pin to Pin, the inverter BMS (RS485-2/CAN) port pin and RS485-1 port pin assignment shown as below:

No.	BMS port (RS485-2/CAN)	RS485-1 port (Reserve)
1	RS485-B	RS485-B
2	RS485-A	RS485-A
3	--	GND_ISO
4	CAN-H	--

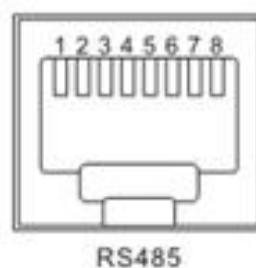

5	CAN-L	--
6	--	5V_ISO
7	RS485-A	RS485-A
8	RS485-B	RS485-B

### 3.7. LCD setting

When connecting a lithium battery BMS, match the battery list parameters in section 6 of the inverter according to the battery pack specifications, and set the battery type to the closest one of "LF15/LF16/ N13/N14" in the inverter Settings. At the same time, after setting the battery type in parameter name "Battery type", switch to parameter name "RS485-2" to select the communication mode, and finally switch to "BMS protocol" to select the corresponding BMS communication protocol.

Battery type	USER	User-defined; all battery parameters can be set.
	SLd	Sealed lead-acid battery; constant-voltage charge voltage: 57.6V, floating charge voltage: 55.2V.
	FLd	Vented lead-acid battery; constant-voltage charge voltage: 58.4V, floating charge voltage: 55.2V.
	GEL default	Colloidal lead-acid battery; constant-voltage charge voltage: 56.8V, floating charge voltage: 55.2V.
	LFP15/LFP16	Lithium iron phosphate battery LFP15/LFP16, corresponding to 15 strings and 16 strings of lithium iron phosphate battery; for 16 strings, default constant-voltage charge voltage is 56.8V; for 15 strings, default constant-voltage charge voltage is 53.2V; allow adjustable.
	NCM14	Ternary lithium battery; which is adjustable. The default constant voltage charging voltage of NCM 14 series is 57.6V.

RS485-2 communication	DIS default	RS485-2 Disable the BMS communication. However, our PC and remote monitoring protocol can continue to be used.
	BMS	RS485-2 port for BMS communication.
BMS protocol Settings	When the setting Program [23] is RS485, the corresponding lithium battery manufacturer brand needs to be selected for communication	
	Pylon , Aoguan, Oulite, Gotion, Sunwoda, CF, Dyness, Pace, BST, Fox-ess, AEC, PylonV3.5, UZ, EVI, Voltronic.	

### 3.8、 Communicating with battery BMS in parallel system

If need to use communicate with BMS in a parallel system, you should make sure to connect the BMS communication cable between the battery and one inverter of the parallel system. It' s recommended to connect to the master inverter of the parallel system.

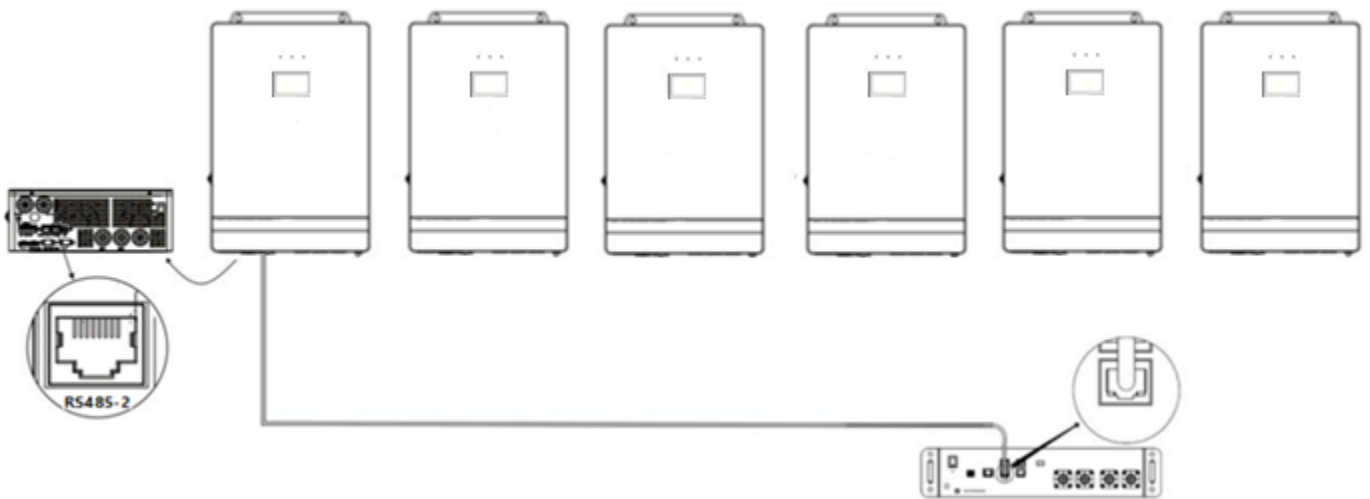

### 3.9、 AC Input/Output Connection

**CAUTION!!** Before connecting to AC input power source, please install a separate AC breaker between inverter and AC input power source. This will ensure the inverter can be securely disconnected during maintenance and fully protected from over current of AC input.

**CAUTION!!** There are two terminal blocks with "IN" and "OUT" markings. Please do NOT mis-connect input and output connectors.

**WARNING!** All wiring must be performed by a qualified personnel.

**WARNING!** It' s very important for system safety and efficient operation to use appropriate cable for AC input connection. To reduce risk of injury, please use the proper recommended cable size as below.

**Suggested cable requirement for AC wires:**

Models	Recommended AC input wiring diameter	Maximum bypass input current	Recommended air switch or circuit breaker type	Torque Value
AS123048-M220-A/ AS123048-M220-B	13mm <sup>2</sup> /6AWG	60A	3P—63A	1.2-1.6Nm
AS103048-M200-A/ AS103048-M200-B	13mm <sup>2</sup> /6AWG	60A	3P—63A	1.2-1.6Nm

Models	Recommended AC output wiring diameter	Maximum bypass output current	Recommended air switch or circuit breaker type	Torque Value
AS123048-M220-A/ AS123048-M220-B	13mm <sup>2</sup> /6AWG	60A	3P—63A	1.2-1.6Nm
AS103048-M200-A/ AS103048-M200-B	13mm <sup>2</sup> /6AWG	60A	3P—63A	1.2-1.6Nm

**Please follow below steps to implement AC input/output connection:**

- 1、 Before making AC input/output connection, be sure to open DC protector or disconnector first.
- 2、 Remove insulation sleeve 10mm for eight conductors. And shorten phase L and neutral conductor N 3mm.
- 3、 Insert AC input wires according to polarities indicated on terminal block and tighten the terminal screws. Be sure to connect PE  protective conductor first .

	→Ground (yellow-green)
	L1、 L2→LINE
	N→Neutral

	<b>WARNING:</b> Be sure that AC power source is disconnected before attempting to hardwire it to the unit.
---	--

- 4、 Then, insert AC output wires according to polarities indicated on terminal block and tighten terminal screws. Be sure to connect PE  protective conductor first.
- 5、 Make sure the wires are securely connected.

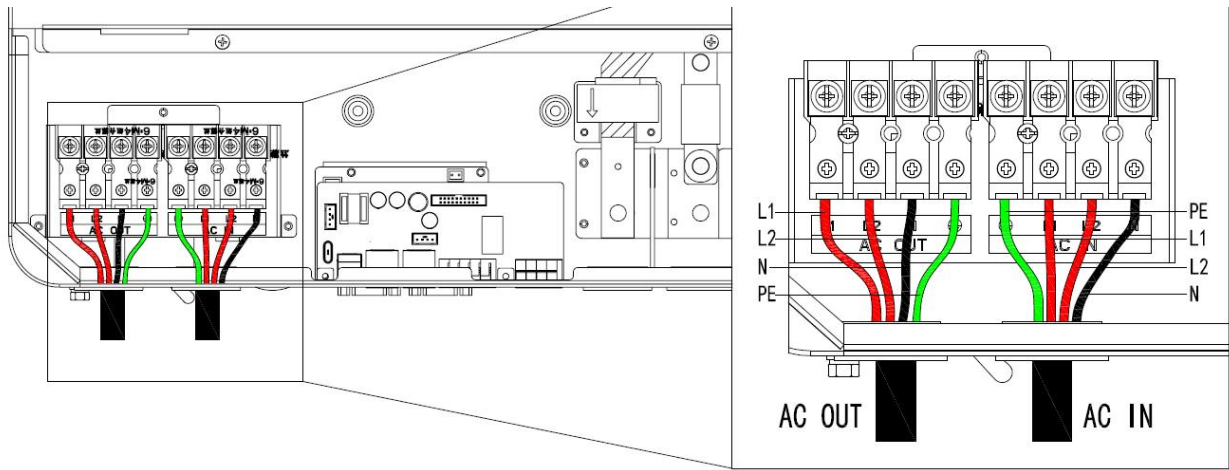

**CAUTION: Important**

Be sure to connect AC wires with correct polarity. If L and N wires are connected reversely, it may cause utility short-circuited when these inverters are worked in parallel operation.

**CAUTION:** Appliances such as air conditioner are required at least 2~3 minutes to restart because it' s required to have enough time to balance refrigerant gas inside of circuits. If a power shortage occurs and recovers in a short time, it will cause damage to your connected appliances. To prevent this kind of damage, please check with manufacturer of air conditioner that if it' s equipped with time-delay function before installation. Otherwise, this off grid solar inverter will trig overload fault and cut off output to protect your appliance but sometimes it still causes internal damage to the air conditioner.

**3.10、 PV Connection**

**CAUTION:** Before connecting to PV modules, please install separately a DC circuit breaker between inverter and PV modules.

**WARNING!** All wiring must be performed by a qualified personnel.

**WARNING!** Do not connect one PV string to more than one inverter at the same time. Otherwise, it may cause damage to the inverter.

**WARNING!** It' s very important for system safety and efficient operation to use appropriate cable for PV module connection. To reduce risk of injury, please use the proper recommended cable size as below.

Models	Recommended PV wiring diameter	Maximum PV input current	Recommended air switch or circuit breaker type	Torque value
AS123048-M220-A/ AS123048-M220-B	5.2mm <sup>2</sup> /10AWG	22A	2P—32A	1.2-1.6Nm
AS103048-M200-A/ AS103048-M200-B	5.2mm <sup>2</sup> /10AWG	22A	2P—32A	1.2-1.6Nm

**PV Module Selection:**

When selecting proper PV modules, please be sure to consider below parameters:

1. Open circuit Voltage (Voc) of PV not exceeds max. PV array open circuit voltage of inverter.
2. Open circuit Voltage (Voc) of PV array should be higher than start-up voltage.

<b>INVERTER MODEL</b>	AS103048-M200-A/ AS103048-M200-B	AS123048-M220-A/ AS123048-M220-B
<b>Max. PV Array Open Circuit Voltage</b>	500Vdc	
<b>Start-up Voltage</b>	120Vdc	
<b>PV Array MPPT Voltage Range</b>	90Vdc~450Vdc	

Please follow below steps to implement PV module connection:

1. Remove insulation sleeve 10 mm for positive and negative conductors.

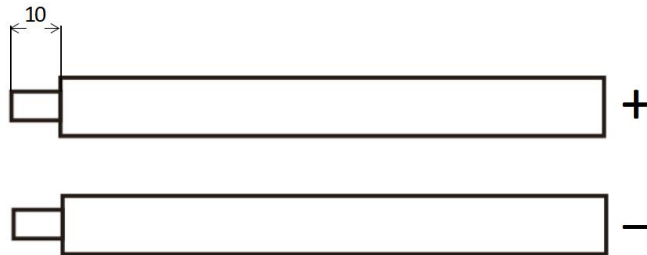

2. Check correct polarity of connection cable from PV modules and PV input connectors. Then, connect positive pole (+) of connection cable to positive pole (+) of PV input connector. Connect negative pole (-) of connection cable to negative pole (-) of PV input connector.
3. Make sure the wires were securely connected.

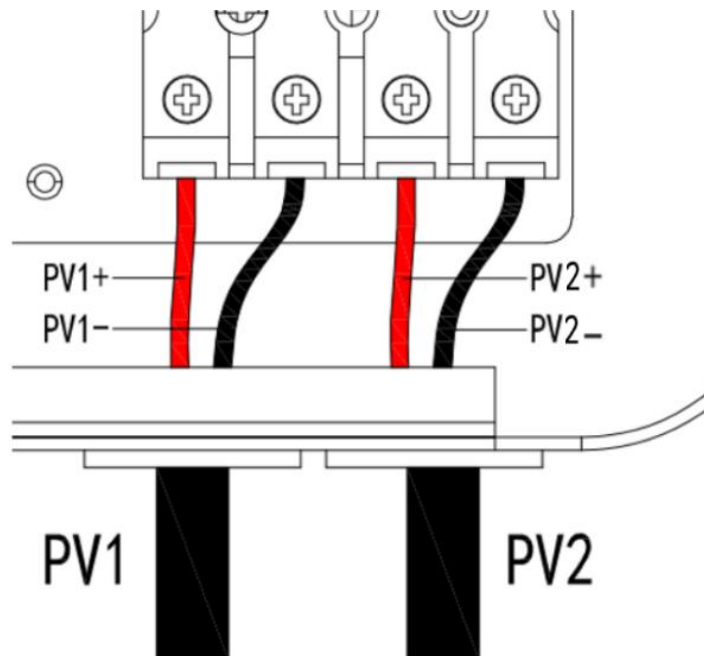

### 3.11、 Final Assembly

After connecting all wiring, please put bottom cover back by screwing four screws as shown below.

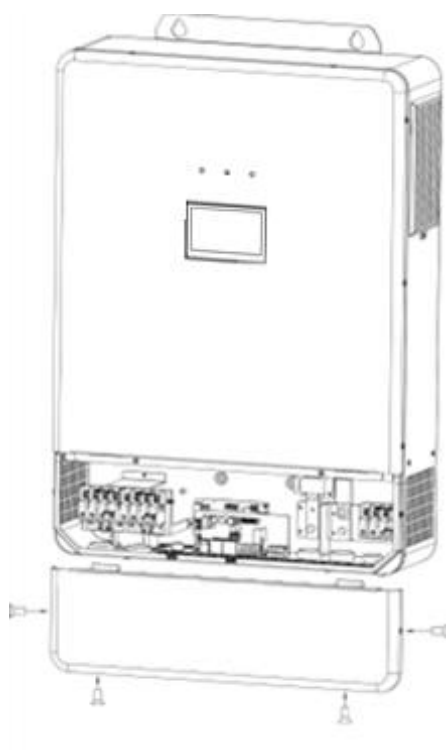

### 3.12、 Starting inverter

Step 1: Close the battery circuit breaker.

Step 2: Press the boat switch at the bottom of the inverter, and the screen and indicator light up, indicating that the inverter has been activated.

Step 3: Close the circuit breakers of PV, AC input and AC output in turn.

Step 4: Start the load one by one according to the order of power from small to large.

## 4. Operation

### 4.1、 Power ON/OFF

Once the unit has been properly installed and the batteries are connected well, simply press On/Off switch (located on the button of the case) to turn on the unit.

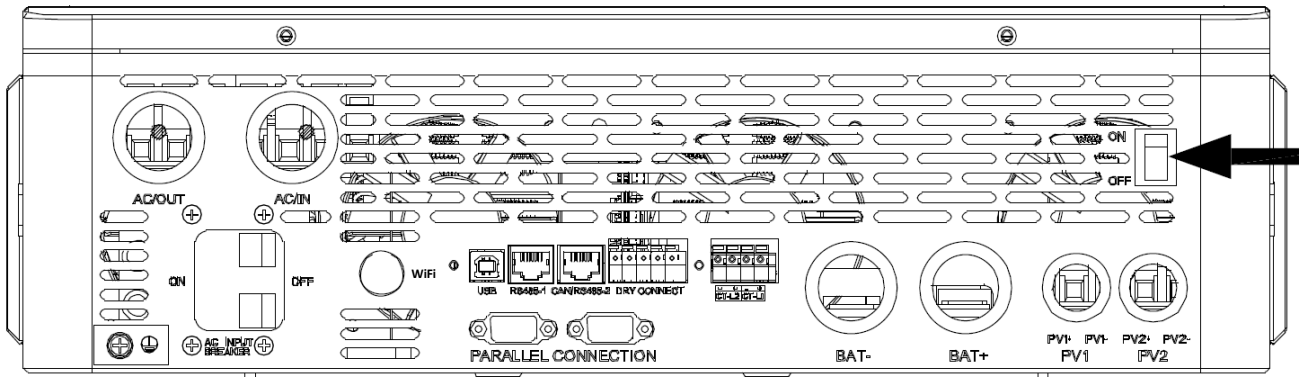

### 4.2、 Operation and Display Panel

The operation and display panel, shown in below chart, is on the front panel of the inverter. It includes three indicators and a LCD display, indicating the operating status and input/output power information.

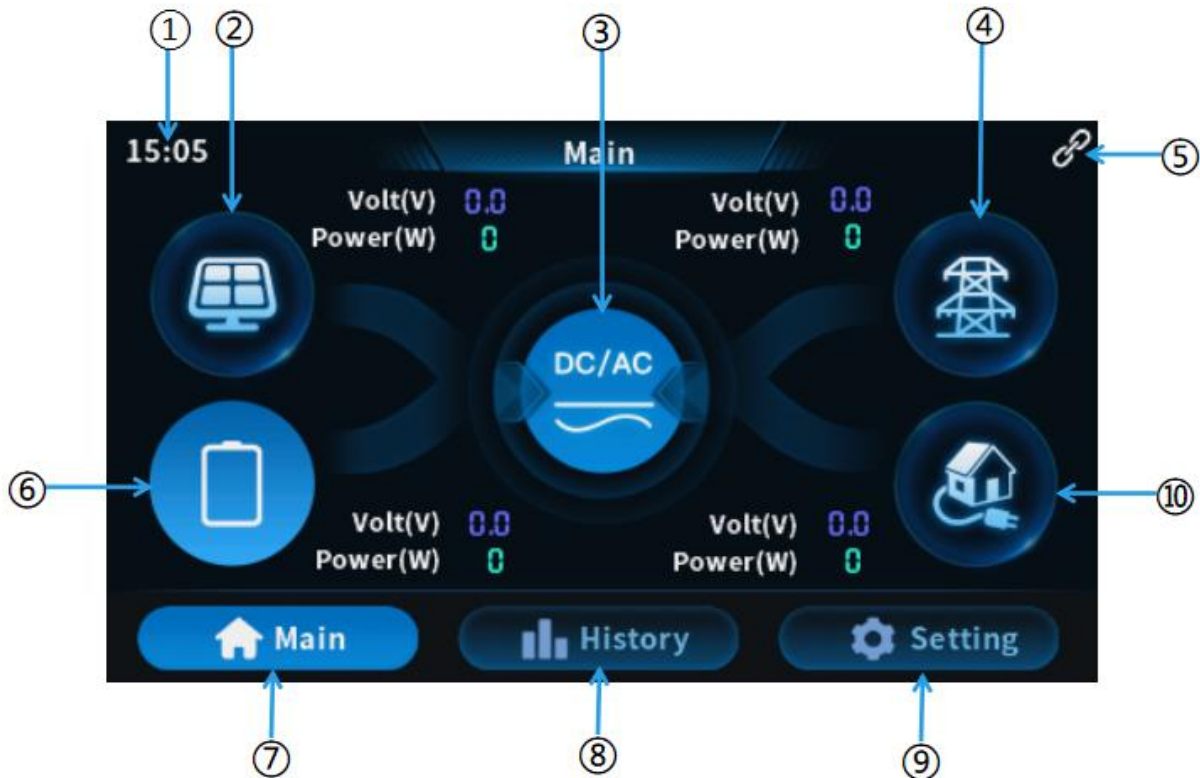

①	Time	⑥	Battery parameters
②	Photovoltaic (PV) parameters	⑦	Main
③	System information	⑧	Historical data
④	AC input parameters	⑨	Setting
⑤	Screen communication	⑩	AC output parameters

LCD screen set menu :



**Real-time data viewing method**

On the LCD main screen, press the screen to scroll through the real-time data of the machine.

**4.3. Setup parameters description**

Screen operation instructions : Press the "Setting" button to enter the setup menu; After entering the Settings menu, you can choose the options to be set and click to enter, then press "<" and ">" Select the value of the parameters to be set, and then press "Confirm" to upload the set parameters.

**Note: in parallel mode, all machines will synchronize the setting parameters of the host (the machine with "Main" is displayed on the display screen) before startup. After startup, the setting parameters of any machine will be synchronized to other machines in the system.**

Parameter name	Settings	Description
<b>Normal setting</b>		
AC output mode priority	Mains default	Mains priority mode, switching to inverter only when the mains fails.
	Battery	Battery priority mode. Switch to mains power only when the battery is under voltage or lower than the setting value of parameter "inv to line volt" ; Switch to battery discharge only when the battery is fully charged or higher

		than the setting value of parameter <b>“line to inv volt”</b> .
	PV	Solar priority mode, switching to the Mains when the solar fails or the battery is lower than the set value of parameter <b>“inv to line volt”</b> .
	Hybrid	Hybrid mode, you can set this mode through the <b>“hybrid→mixed mode”</b> setting item.
AC output phase voltage setting	120Vac <b>default</b>	Allow to set to 100Vac/105Vac/110Vac/120Vac/127Vac, default 120V. The rated output power will be reduced= $(\text{Power Rate}) \times (\text{Vset}/120)$
AC output Frequency	50.0HZ	Bypass self-adaptation; when the mains is connected, it automatically adapts to the mains frequency; when the mains is disconnected, the output frequency can be set through this menu. The default output frequency to 60Hz of the 120Vac.
	60.0HZ	
AC Input Voltage Range	<b>UPS default</b>	Narrow mains input voltage range of 120Vac machine: 90~140Vac(Lower input voltage limit becomes 85V when system voltage is 100V / 105V); Frequency range: 47~ 55Hz (50Hz);57Hz ~ 65Hz (60Hz);
	Generator	Diesel generators input, need to set this mode, at this time: Narrow Ac input voltage range of 120Vac machine: 90~140Vac Frequency range: 40~ 70Hz
Power saving mode	<b>Disable default</b>	Power saving mode disabled.
	Enable	After the power saving mode is enabled, if the load per phase is null or less than 25W, the inverter output is turned off after a delay for a certain period of time. When the load of any phase is more than 50W, the inverter automatic restart.
Charger source priority	Hybrid charging <b>default</b>	PV and Mains hybrid charging; PV charging is a priority, and when the PV energy is insufficient, the Mains charging supplements. When the PV energy is sufficient, the Mains charging stops. Note: Only when the Mains bypass output is loaded, the

		PV charging and the mains charging can work at the same time. When the inverter works, only the PV charging can be started.
	Mains priority	Mains priority charging; only when the mains charging fails, the PV charging is started.
	PV priority	PV priority charging; only when the PV charging fails, the mains charging is started.
	PV Only charging	Only PV charging, with the Mains charging not activated.
AC output phase setting	Same phase	Stands for single-phase mode. The phase same of L1-L2 is 0 degree, L1/L2 in parallel connection. As AC output voltage setting was 120Vac, therefore L1-N/L2-N voltage was 120Vac, L1-L2 voltage was 0Vac. Setting allowed only when output is switched off.
	Split 120	Stands for split-phase mode. The phase difference of L1-L2 is 120 degree, L1/L2 in split connection. As AC output voltage setting was 120Vac, therefore L1-N/L2-N voltage was 120Vac, L1-L2 voltage was 208Vac. Setting allowed only when output is switched off.
	Split 180	Stands for split-phase mode. The phase difference of L1-L2 is 180 degree, L1/L2 in split connection. As AC output voltage setting was 120Vac, therefore L1-N/L2-N voltage was 120Vac, L1-L2 voltage was 240Vac. Setting allowed only when output is switched off.
Max total charging current	60A <b>default</b>	Maximum total charging current setting. setting range:0~220A.
Max AC charger current	120A <b>default</b>	Setting range: 0~160A.
Buzzer mute	Disable <b>default</b>	Alarm beep is enabled when the status of the main input source changes or the inverter fails.
	Enable	Buzzer was silent.
Fully charging judgment current setting	3A <b>default</b>	The battery type is lead-acid, when the battery voltage was greater than or equal to the floating charge value, and the charging current is less than the setting value, the battery is considered to be fully charged and the charging is stopped; If the battery type is lithium battery, when the battery voltage was greater than or equal to the

		constant voltage charging value and the charging current was less than the set value, the battery would be considered to be fully charged, the charging would be stop.
N-PE connection switchover is enabled	Disable <b>default</b>	Don' t automatically connect the N wire to the PE wire under any working conditions.
	Enable	When there is no mains input off the grid, the neutral line automatically connects to the PE. When the bypass has mains input, the neutral line is automatically disconnected from the PE.
AC Overload Restart Enable	Disable	Overload automatic restart is prohibited. If overload shutdown output occurs, the machine will no longer start on.
	Enable <b>default</b>	Enable overload automatic restart. If overload shutdown output occurs, the machine will restart the output after a delay of 3 minutes. After a total of 5 times in 30 minutes, the startup system is no longer resumed.
<b>Battery setting</b>		
Automatic battery activation	Disable	When the battery is dormant or not connected, the PV or mains does not automatically activate the battery to turn on the battery output.
	Enable <b>default</b>	When the battery is dormant or not connected, the PV or mains automatically activates the battery to turn on the battery output.
Battery type	USER	User-defined; all battery parameters can be set.
	SLD	Sealed lead-acid battery; constant-voltage charge voltage: 57.6V, floating charge voltage: 55.2V.
	FLD	Vented lead-acid battery; constant-voltage charge voltage: 58.4V, floating charge voltage: 55.2V.
	GEL <b>default</b>	Colloidal lead-acid battery; constant-voltage charge voltage: 56.8V, floating charge voltage: 55.2V.
	LFP15/ LFP16	Lithium iron phosphate battery LFP15/LFP16, corresponding to 15 strings and 16 strings of lithium iron phosphate battery; for 16 strings, default constant-voltage charge voltage is 56.8V; for 15 strings, default constant-voltage charge voltage is 53.2V; Allow adjustable.

	NCM14	Ternary lithium battery; which is adjustable. The default constant voltage charging voltage of NCM 14 series is 57.6V.
Battery pack rate AH	300AH	Lead-acid battery capacity.
Battery constant charge voltage	57.6V <b>default</b>	C.V. charging voltage setting; the setting range is 48V~58.4V, with step of 0.1V; it is valid for user-defined battery and lithium battery.
Battery floating charge voltage	55.2V <b>default</b>	Floating charge voltage, setting range: 48V~58.4V, step: 0.1V.
Battery recharge recovery point	52V <b>default</b>	After the battery is fully charged, the inverter stops charging, and restarts charging when the battery voltage is lower than the voltage value.
Battery Power to mains	46V <b>default</b>	When the parameter <b>“Output source priority”</b> = Bat, the battery voltage is lower than the set value, and the output is switched from the inverter to the mains. Setting range: 44V~52V.
Mains power to battery	57.6V <b>default</b>	When the parameter <b>“Output source priority”</b> = Bat, the battery voltage is higher than the set value, and the output is switched from the mains to the inverter. Setting range: 48V~60V.
Low battery voltage alarm	44V <b>default</b>	Battery undervoltage alarm point; when the battery voltage is lower than the point, an undervoltage alarm is given (01 fault), and the output is not turned off; the setting range is 40V~52V, with a step of 0.1V.
Delay off discharge	42V <b>default</b>	Over-discharge voltage; when the battery voltage is lower than this judgment point, delay the time set by parameter <b>“battery over discharge delay time”</b> and turn off inverter output. Setting range is 40V~48V, with a step of 0.1V.
Battery over discharge voltage (immediately off discharge)	42V <b>default</b>	Battery discharge limit voltage; when the battery voltage is lower than the point, the output is turned off immediately (02 fault); the setting range is 40V~52V, with a step of 0.1V. It is valid for user-defined battery and lithium battery.
Off discharge delay time	5s <b>default</b>	Over-discharge delay time; when the battery voltage is lower than the parameter <b>“battery over discharge voltage (delay off)”</b> the inverter output will be turned

		off after the time set by this parameter is delayed. The setting range is 5S~120S, with a step of 1S.
Over discharge recovery (02 fault)	52V <b>default</b>	When the battery over discharge protection disconnects the inverter output, the battery voltage must be greater than this value to restore the inverter AC output.
Timed charging	Disable <b>default</b>	Disable this function.
	Enable	Enable this function, utility charging the battery and carry load only in charging time slot which user set or the battery is under voltage.
	0h 0min	1st slot start charging; range: 00:00-23:59
	0h 0min	1st slot end charging; range: 00:00-23:59
	0h 0min	2st slot start charging; range: 00:00-23:59
	0h 0min	2st slot end charging; range: 00:00-23:59
	0h 0min	3st slot start charging; range: 00:00-23:59
	0h 0min	3st slot end charging; range: 00:00-23:59
Timed discharging	Disable <b>default</b>	Disable this function.
	Enable	Enable this function, battery discharging only in discharging time slot which user set or utility is not available.
	0h 0min	1st slot start discharging; range: 00:00-23:59
	0h 0min	1st slot end discharging; range: 00:00-23:59
	0h 0min	2st slot start discharging; range: 00:00-23:59
	0h 0min	2st slot end discharging; range: 00:00-23:59
	0h 0min	3st slot start discharging; range: 00:00-23:59
	0h 0min	3st slot end discharging; range: 00:00-23:59
Constant voltage charging time	120min <b>default</b>	C. V. charging maximum time setting, which means the maximum charging time to reach the set voltage of parameter " <b>battery equalizing charge voltage</b> "

		during constant-voltage charging. The setting range is 5min~900min, with a step of 1minutes. It is valid for user-defined battery and lithium battery.
<b>Parallel setting</b>		
Parallel AC output mode setting <b>(can be set in the standby mode only)</b>	Single <b>default</b>	When single inverter is used, the default is SIG mode.
	PAL	In parallel operation with single phase. Please refer to <b>8.3</b> Wiring Diagram.
Communication address	<b>1 default</b>	Parallel mode needs to be set in the range of 1-6, the ID cannot be repeated. When the power is first turned on, it will be automatically distributed; Single mode setting range 1-254.
Battery connected independently	Disable <b>default</b>	Parallel use of all battery packs.
	Enable	Battery pack not connected in parallel. Each battery is connected to each inverter.
<b>BMS setting</b>		
Communication type	OFF <b>default</b>	Turn off BMS communication function.
	485-BMS	BMS communicates through RS485-2.
	CAN-BMS	BMS communicates through CAN.
BMS protocol Settings	When the BMS communication setting was on, the corresponding lithium battery manufacturer brand needs to be selected for communication. Pylon , Aoguan, Oulite, Gotion, Sunwoda, CF, Dyness, Pace, BST, Fox-ess, AEC, PylonV3.5, UZ, EVI, Voltronic.	
SOC discharging alarm (Optional when BMS is enabled)	15% <b>default</b>	After the BMS of the setting item <b>BMS</b> is enabled, the machine will alarm 07 if the battery capacity rate is lower than this value, and the alarm will be cleared if the battery capacity rate is higher than 5% of this value.
SOC switching mains (optional when BMS is enabled)	10% <b>default</b>	After the BMS of the setting item <b>BMS</b> is enabled, the machine will switch to the mains when the battery capacity rate is lower than this value and the mains power is available.

SOC switching inverter (optional when BMS is enabled)	100% <b>default</b>	After the BMS of the setting item <b>BMS</b> is enabled, it takes effect in battery priority mode. If the battery capacity rate is higher than this value, the machine will switch from the mains to the inverter mode.
SOC discharge off (optional when BMS is enabled)	5% <b>default</b>	After the BMS of the setting item <b>BMS</b> is enabled, if the battery capacity rate is lower than this value, the machine will report 08 fault and cut off the power supply or output.
SOC charging off (optional when BMS is enabled)	100% <b>default</b>	After the BMS of the setting item <b>BMS</b> is enabled, when the battery capacity rate is higher than this value, the inverter considers the battery to be full. If the battery priority mode is adopted at this time, the machine will switch the battery back from the mains.
SOC exit forced charging(optional when BMS is enabled)	10% <b>default</b>	After the BMS of the setting item <b>BMS</b> is enabled, when the inverter receives a forced charging command from BMS, it will force charging the battery. When the battery capacity rate is higher than this value, the inverter will exit the force charging mode and continue running the set current mode.
Charging Strategy Options	BMS+inverter	The maximum charging current of the battery is limited according to the descending logic of the machine.
	BMS only	The maximum charging current of the battery is limited according to the current limit value of BMS.
	Manual setup	The maximum charging current of the battery is limited according to the set value of item .
<b>Hybrid setting</b>		
Hybrid way(available for some models, Hybrid mode available)	Constant Power On Grid	Photovoltaic power generation has enough load power, and the excess is grid-connected power generation.
	Energy To Output <b>default</b>	Inverter power generation energy only to the load (generation power < Load power). Note: mixed load, mains and photovoltaic are loaded together, photovoltaic is not enough to supplement the mains.
	CurrAntiRev (CT)	Anti-countercurrent, self-use according to the load power, do not input current to the mains.

On-grid power	0w <b>default</b>	Active power that can be connected to the mains grid , setting range: 0w-12000w(120M) / 0w-10000w(100M).
Hybrid priority (Effective when mains output is on)	Disable <b>default</b>	The PV energy is prioritized to charge the battery, and the excess energy is then generated to the grid.
	Enable	The PV energy is preferentially transmitted to the power grid for generation, and the excess energy is then supplied to the battery for charging.
External CT Get Host Enable	Disable <b>default</b>	Only control the grid-connected power of this inverter.
	Enable	Anti-backflow host,plug the CT into this inverter, to control the total grid-connection power.
<b>Others setting</b>		
Backlight off	5min <b>default</b>	Can adjust the screen brightness time.
Brightness	10% <b>default</b>	Can adjust the screen brightness.
On/off control	ON	Turn on the inverter AC output.
	OFF	Turn off the inverter AC output.
Restart control	Restart	Restart the inverter.
Language	English <b>default</b>	Switching between Chinese and English.
Present time	2000/01/01 0:0:00	Time setting.
Screen calibration	Calibrate	Calibrate the screen touch position.
Screen buzzer	Disable	The screen buzzer is silent.
	Enable <b>default</b>	The buzzer sounds when touching the screen.

# 5. Operating Mode Description

## 5.1. Charging mode

1) **PV priority:** PV module will charge the battery preferentially, and the battery is charged by the Mains only when the PV system fails. During the day, solar energy is fully used to charge, while at night, it converts to the Mains. This can maintain battery level, and is ideal for areas where the grid is relatively stable and electricity price is relatively high.

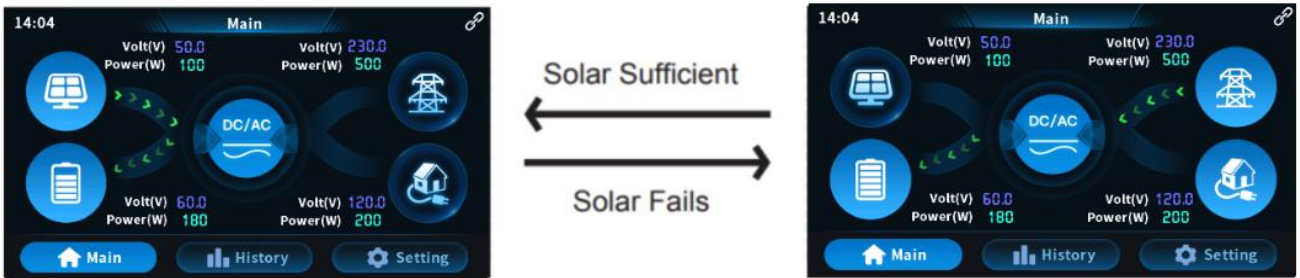

2) **Mains priority:** The Mains supply is preferentially used to charge the battery. Only when the Mains fails, the PV charging can be activated.

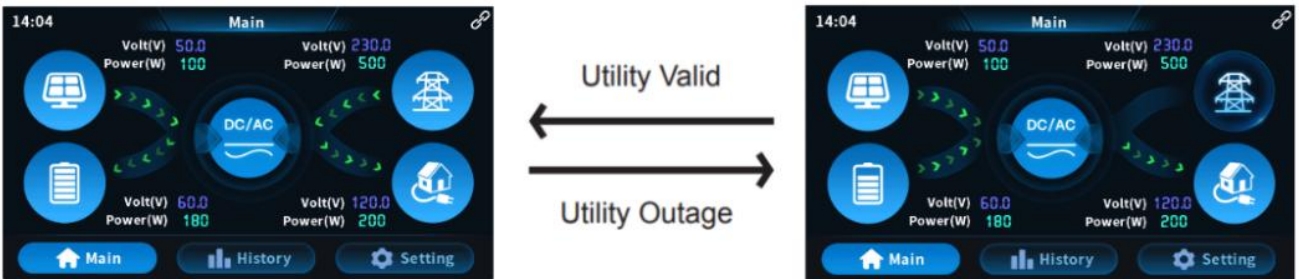

3) **Hybrid charging:** PV and mains hybrid charging. PV MPPT charging is a priority, and when PV energy is insufficient, the mains supply supplements. When the PV energy is sufficient again, the mains stops charging. This is the fastest charging mode, suitable for the areas where power grid is unstable, providing sufficient backup power supply at any time.

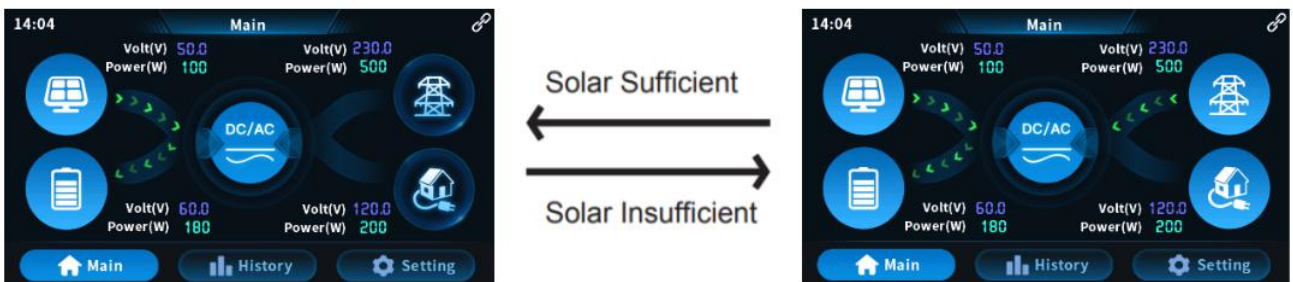

4) **Only Solar:** Only PV charging, without Mains charging. This is the most energy-efficient way in which battery is charged only by solar panels, and is usually used in areas with good lighting conditions.



5.2、 AC output mode

➤ **PV priority mode:**

Photovoltaics and batteries power the load, switch to mains supply when the PV charging fails. This mode maximizes the use of solar energy while maintaining battery power, suitable for use in the areas with relatively stable grid.

**Power supply priority: Solar→Battery→Utility.**

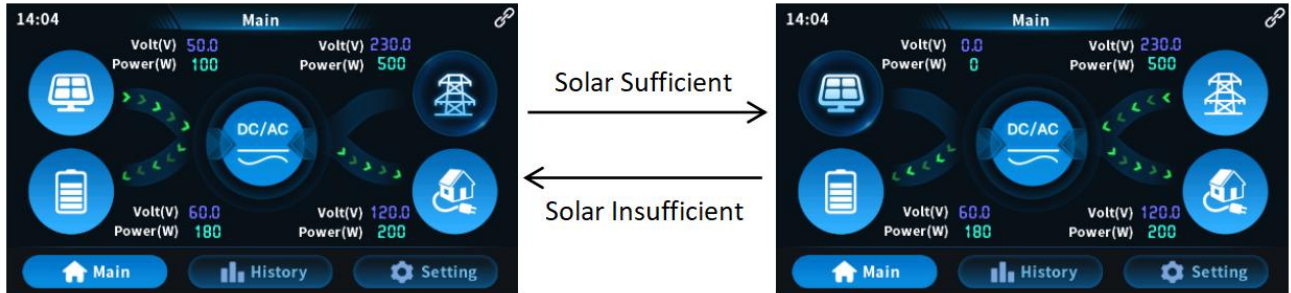

➤ **Mains priority mode:**

Switch to inverter only when the mains fails (when there was mains power, switch to mains power for charging and power supply).Then, the unit is equivalent to a backup UPS, suitable for areas with unstable grid. Switching does not affect PV charging.

**Power supply priority: Utility→Solar→Battery.**



➤ **Battery priority mode:**

Switch to mains supply only when the battery discharge undervoltage is lower than the set point (16 setting item). When the charging battery is higher than the set point of (17 setting item), switch to the battery discharge mode. This can cycle the battery charge and discharge. This mode maximizes the use of DC power and is used in the area with stable grid. Switching does not affect PV charging.

**Power supply priority: Solar→Battery→Utility.**

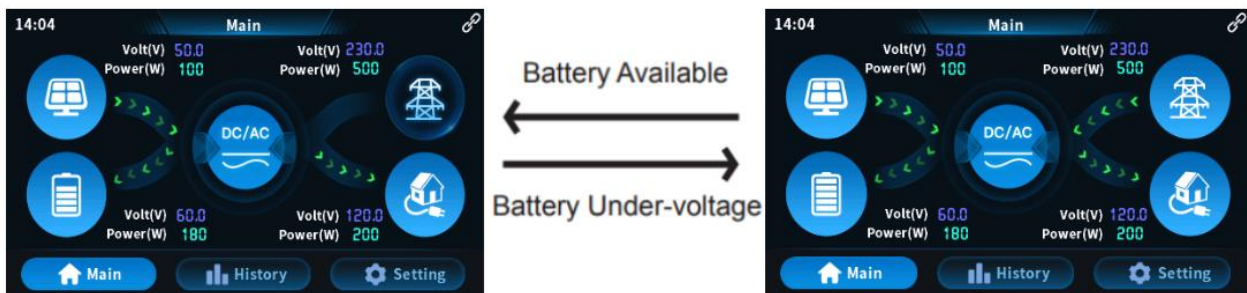

➤ **Hybird mode:**

**Constant Power On Grid:** Photovoltaic power generation has enough load power, and the excess is grid-connected power generation.

**Energy To Output :** Inverter power generation energy only to the load (generation power & Load power).

**Note:** mixed load, mains and photovoltaic are loaded together, photovoltaic is not enough to supplement the mains.

**CurrAntiRev(CT):** Anti-countercurrent, self-use according to the load power, do not input current to the mains.

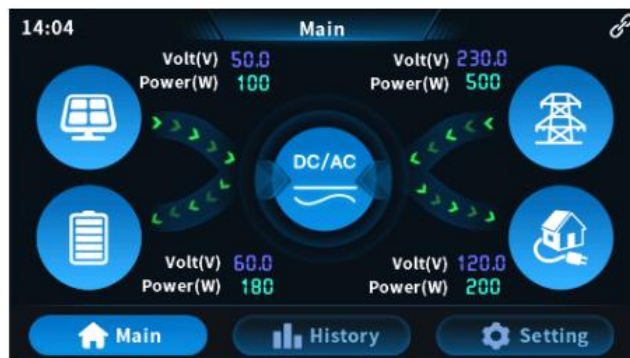

## 6. Battery type parameters

### 6.1、 For Lead-acid Battery

<b>parameter</b> \ <b>Battery Type</b>	<b>Sealed lead acid battery (SLD)</b>	<b>Colloidal lead acid battery (GEL)</b>	<b>Vented lead acid battery (FLD)</b>	<b>User-defined (User)</b>
Overvoltage disconnection voltage	60V	60V	60V	40 ~ 60V (Adjustable)
Battery fully charged recovery point(setup item )	52V (Adjustable)	52V (Adjustable)	52V (Adjustable)	52V (Adjustable)
Boost charge voltage	57.6V	56.8V	58.4V	40 ~ 60V (adjustable)
Floating charge voltage	55.2V	55.2V	55.2V	40 ~ 60V (adjustable)
Undervoltage alarm voltage(01 fault)	44V	44V	44V	40 ~ 60V (adjustable)
Undervoltage alarm voltage recovery point(01 fault)	Undervoltage alarm voltage+0.8V			
Low voltage disconnection voltage(02 fault)	42V	42V	42V	40 ~ 60V (Adjustable)
Low voltage disconnection voltage recovery point (02 fault)	52V (Adjustable)	52V (Adjustable)	52V (Adjustable)	52V (Adjustable)
Discharge limit voltage	40V	40V	40V	40 ~ 60V (Adjustable)
Over-discharge delay time	5s	5s	5s	1 ~ 30s (Adjustable)
Boost charge duration	120 minutes	120 minutes	120 minutes	10 ~ 600 minutes (Adjustable)

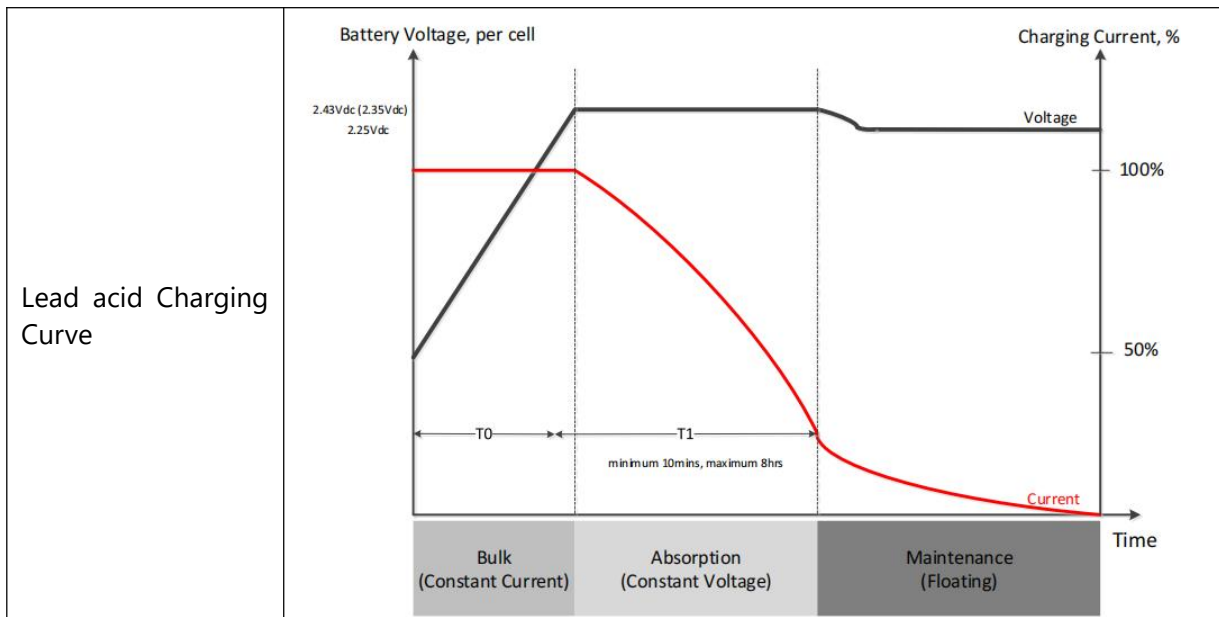

## 6.2、 For Lithium Batter

Battery type	Ternary lithium battery (N14)	Lithium iron phosphate battery (LF16)	Lithium iron phosphate battery (LF15)	Lithium iron phosphate battery (LF14)
<b>Parameters</b>				
Overvoltage disconnection voltage	60V	60V	60V	60V
Battery fully charged recovery point(setup item )	54.8V (Adjustable)	53.6V (Adjustable)	50.4V (Adjustable)	47.6V (Adjustable)
Boost charge voltage	57.6V (Adjustable)	56.8V (Adjustable)	53.2V (Adjustable)	49.2V (Adjustable)
Floating charge voltage	57.6V (Adjustable)	56.8V (Adjustable)	53.2V (Adjustable)	49.2 (Adjustable)
Undervoltage alarm voltage(01 fault)	46.8V (Adjustable)	49.6V (Adjustable)	46.4V (Adjustable)	43.2V (Adjustable)
Undervoltage alarm voltage recovery point(01 fault)	Undervoltage alarm voltage+0.8V			
Low voltage disconnection voltage(04 fault)	42V (Adjustable)	48.8V (Adjustable)	45.6V (Adjustable)	42V (Adjustable)

Low voltage disconnection voltage recovery point (04 fault)(setup item 35)	49.6V (Adjustable)	52.8V (Adjustable)	49.6V (Adjustable)	46V (Adjustable)
Discharge limit voltage	39.2V	46.4V	43.6V	40.8V
Over-discharge delay time	30s (Adjustable)	30s (Adjustable)	30s (Adjustable)	30s (Adjustable)
Boost charge duration	120 minutes (Adjustable)	120 minutes (Adjustable)	120 minutes (Adjustable)	120 minutes (Adjustable)

# 7. Communication

## 7.1. Overview

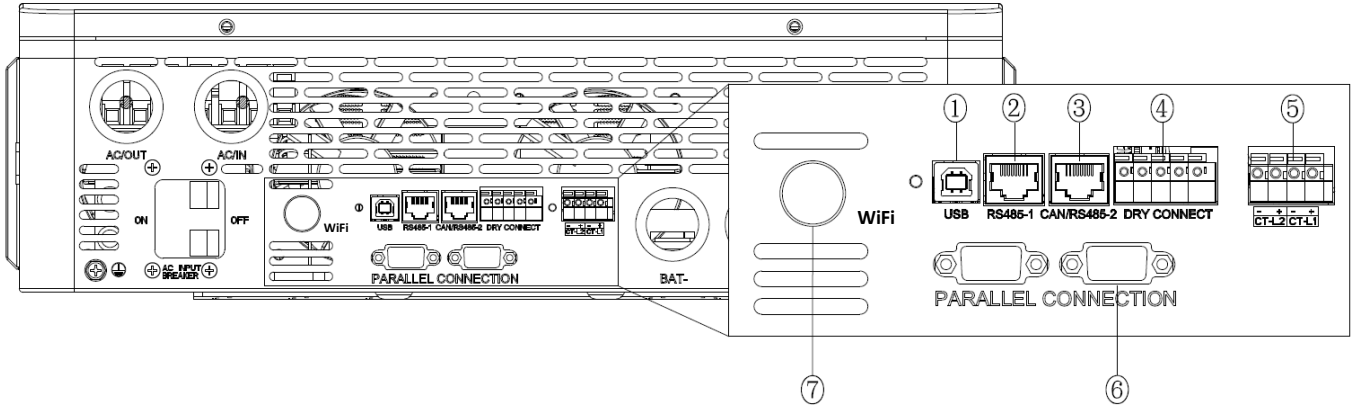

1	USB-B port	2	RS485-1 port	3	RS485-2/CAN port
4	Dry contact port	5	CT sampling detection (anti feed-in)		
6	Parallel communication port	7	WiFi port		

### 7.2. USB communication port

This is a USB communication port, which can be used for USB communication with the optional PC host software. To use this port, you should install the corresponding "USB to serial chip CH340T driver" in the computer.

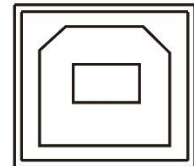

### 7.3. RS485 communication port

This port is an RS485 communication port. There are two RS485 ports: RS485-1 and RS485-2.

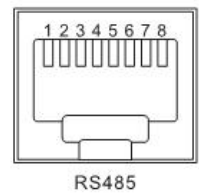

**The RS485 communication port has two functions:**

- 1) RS485 communication with the lithium battery BMS directly via the RS485-2 port (custom required);
- 2) RS485-1/RS485-2 also allows direct connection with the optional RS485 to WiFi/GPRS communication module developed by our company through this port. After the module is selected, you can

connect the inverter through the mobile phone APP, on which you can view the operating parameters and status of the device. (Note: RS485-2 can only be used when BMS is not enabled).

**WiFi wiring and installation guidelines (WiFi optional) :**

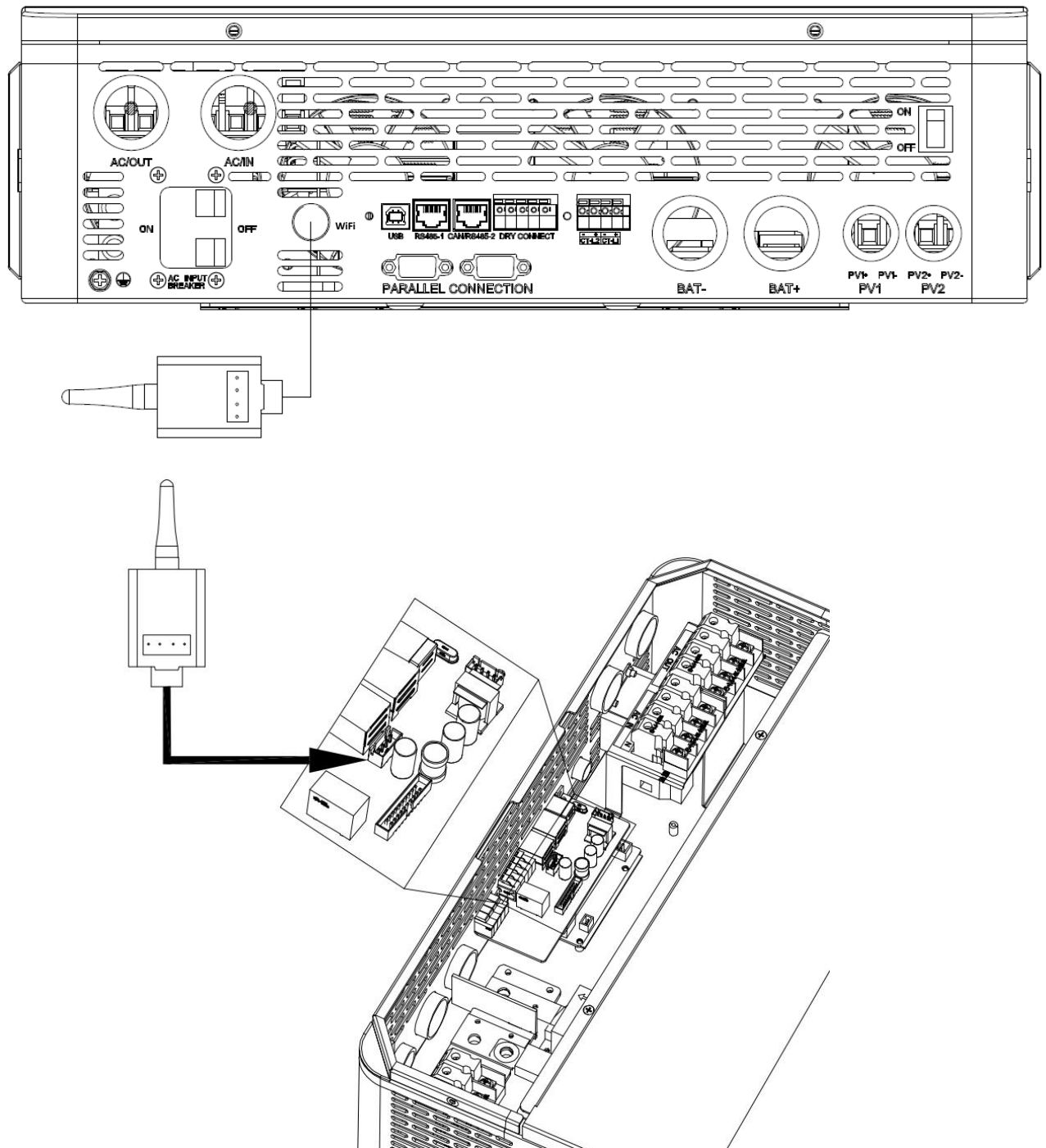

## 7.4. Dry contact port

### N-NO-NC function:

Working principle: This dry node can control the ON/OFF of the diesel generator.

- 1) Normally, NC-N point is connected and the NO-N point is disconnected;
- 2) When the battery voltage reaches the low voltage disconnection point, the relay coil is energized, the NO-N point is connected while NC-N point is disconnected. At this point, NO-N point can drive resistive loads specifications: 125VAC/1A, 230VAC/1A or 30VDC/1A.

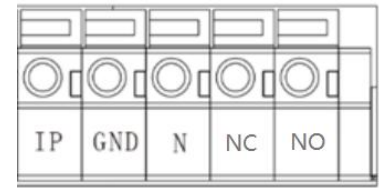

### IP-GND function:

Working principle: This dry node can remote control the AC output power ON/OFF of the inverter.

- 1) IP-GND is disconnected → AC output ON;
- 2) IP-GND is connected → AC output OFF;

## 7.5. CT sampling detection (anti feed-in)

### (CT+)-GND function:

Optional function, not standard function;

Working principle: By sampling the input line current, self-use function is realized. But need to use our configuration of CT sensors;

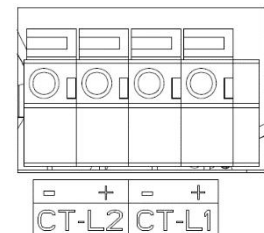

### **WARNING:**

This inverter does not have the corresponding grid-connected authentication, this function can only be off-grid applications; if used for grid-connected use, will violate the local law, specific consultation with local lawyers.

## 7.6. Parallel communication function (parallel operation only)

**Only the "-500 P" model has this feature:**

- a) This port is used for parallel communication, through which the parallel modules can communicate with each other.

- b) Each inverter has two DB15 ports, one for the male connector and the other for the female connector.
- c) When connecting, make sure to connect the male connector of the inverter with the female connector of the inverter to be paralleled, or connect the female connector of the inverter to the male connector of the inverter to be paralleled.
- d) Do not connect the male connector of the inverter to its female connector.

**Female connector**

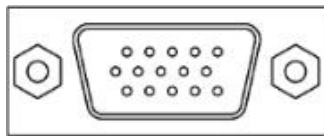

**Male connector**

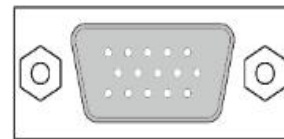

## 8. Parallel installation and wiring

### 8.1. Introduction

- 1、 Maximum six inverters can be used for parallel operation. **Only “-500P” models can support parallel.**
- 2、 When using the parallel operation function, the following connecting lines (package accessories) shall be firmly and reliably connected:

#### Parallel communication line\*1:

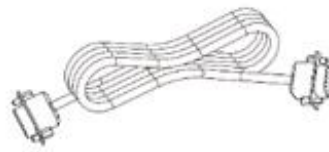

### 8.2. Precautions for connecting the parallel connecting lines

Warning: 

#### 1. Battery wiring:

**Parallel connection of batteries (need to be set through the screen in the “Parallel” menu):** Ensure that all inverters are connected to the same battery, with BAT + connected to BAT + , BAT - connected to BAT - , and that the connection is correct with the same wiring length and line diameter before power on and start-up, so as to avoid the abnormal operation of parallel system output caused by wrong connection.

**Separate connection of batteries (need to be set through the screen in the “Parallel” menu):** Ensure that each inverter was connected to the each battery, with BAT + connected to BAT + , BAT - connected to BAT - , and that the connection is correct with the same wiring length and line diameter before power on and start-up, so as to avoid the abnormal operation of parallel system output caused by wrong connection.

## 2、 AC OUT wiring:

**Parallel connection in split phase:** Ensure L1-to-L1, L2-to-L2, N-to-N and PE-to-PE connection for all inverters, and that the connection is correct with the same wiring length and line diameter before power on and start-up, so as to avoid the abnormal operation of parallel system output caused by wrong connection. For specific wiring, please refer to 8.3 Wiring Diagram.

**Parallel connection in single phase:** Ensure N-to-N and PE-to-PE connection for all all-in-one solar charger inverters. The **L(L1 and L2)** lines of all inverters connected to the same phase need to be connected together. Other connection precautions are the same as parallel connection in single phase. For specific wiring, please refer to 8.3 Wiring Diagram.

## 3、 AC IN wiring:

**Parallel connection in split phase:** Ensure L1-to-L1, L2-to-L2, N-to-N and PE-to-PE connection for all inverters, and that the connection is correct with the same wiring length and line diameter before power on and start-up, so as to avoid the abnormal operation of parallel system output caused by wrong connection. Meanwhile, it is not allowed to have multiple different AC source inputs to avoid damage to the external equipment of the inverter. The consistency and uniqueness of AC source input shall be ensured. For specific wiring, please refer to 8.3 Wiring Diagram.

**Parallel connection in single phase:** Ensure N-to-N and PE-to-PE connection for all all-in-one solar charger inverters. The **L(L1 and L2)** lines of all inverters connected to the same phase need to be connected together. Other connection precautions are the same as parallel connection in single phase. Other connection precautions are the same as parallel connection in single phase. For specific wiring, please refer to 8.4 Wiring Diagram.

#### **4、 Wiring of parallel communication line:**

**Parallel connection in single or split phase:** Our company's parallel communication line is a DB15 standard computer cable with shielding function. Ensure the "one-in-one-out" rule when connecting each inverter, that is, connect the male connector (out) of this inverter with the female connector (in) of the inverter to be paralleled. Do not connect the male connector of the inverter to its female connector. In addition, make sure to tighten the parallel communication line of each inverter with self-contained end screws of DB15 to avoid the abnormal operation or damage of the system output caused by the falling off or poor contact of the parallel communication line.

5、 Before or after connecting the system, please carefully refer to the following system wiring diagram to ensure that all wiring is correct and reliable before power on.

6、 After the system is wired, powered on and in normal operation, if a new inverter needs to be connected, make sure to disconnect the battery input, PV input, AC input and AC output, and that all all-in-one solar charger inverters are powered off before reconnecting into the system.

### 8.3. Schematic diagram of parallel connection in single phase

1. The parallel communication line of the inverter need to be locked with screws after connecting. The schematic diagram is as follows:

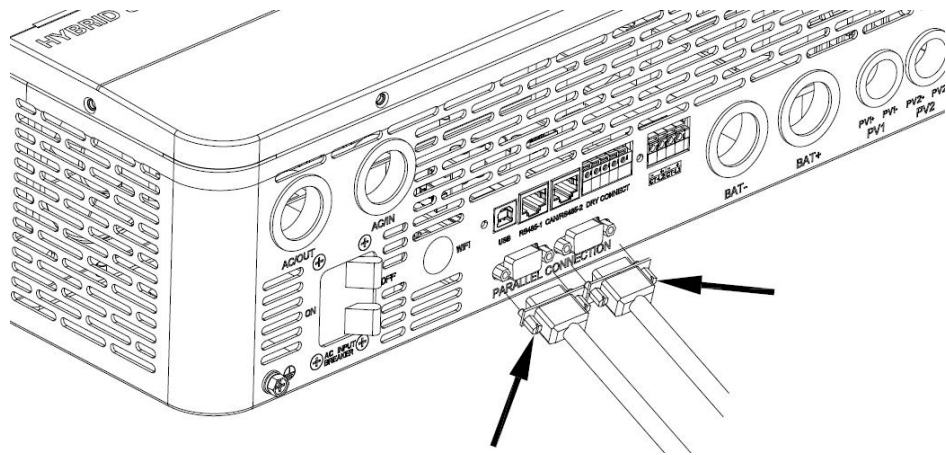

2. In case of parallel operation with multiple inverters, the schematic diagram of parallel connection is as follows:

#### Parallel connection in split phase :

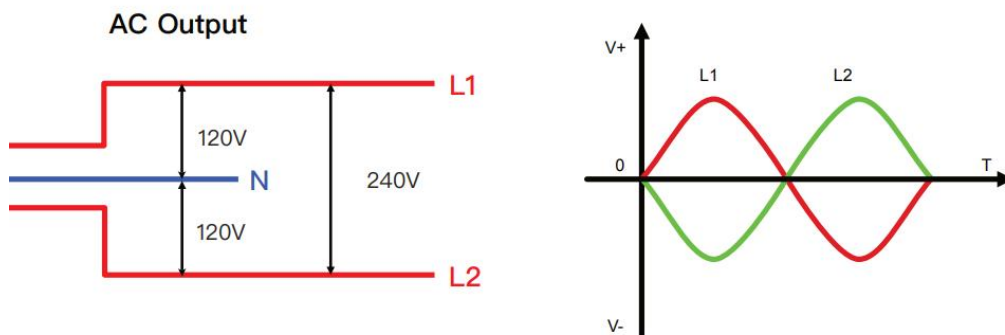

a) six inverters of the system connected in split parallel:

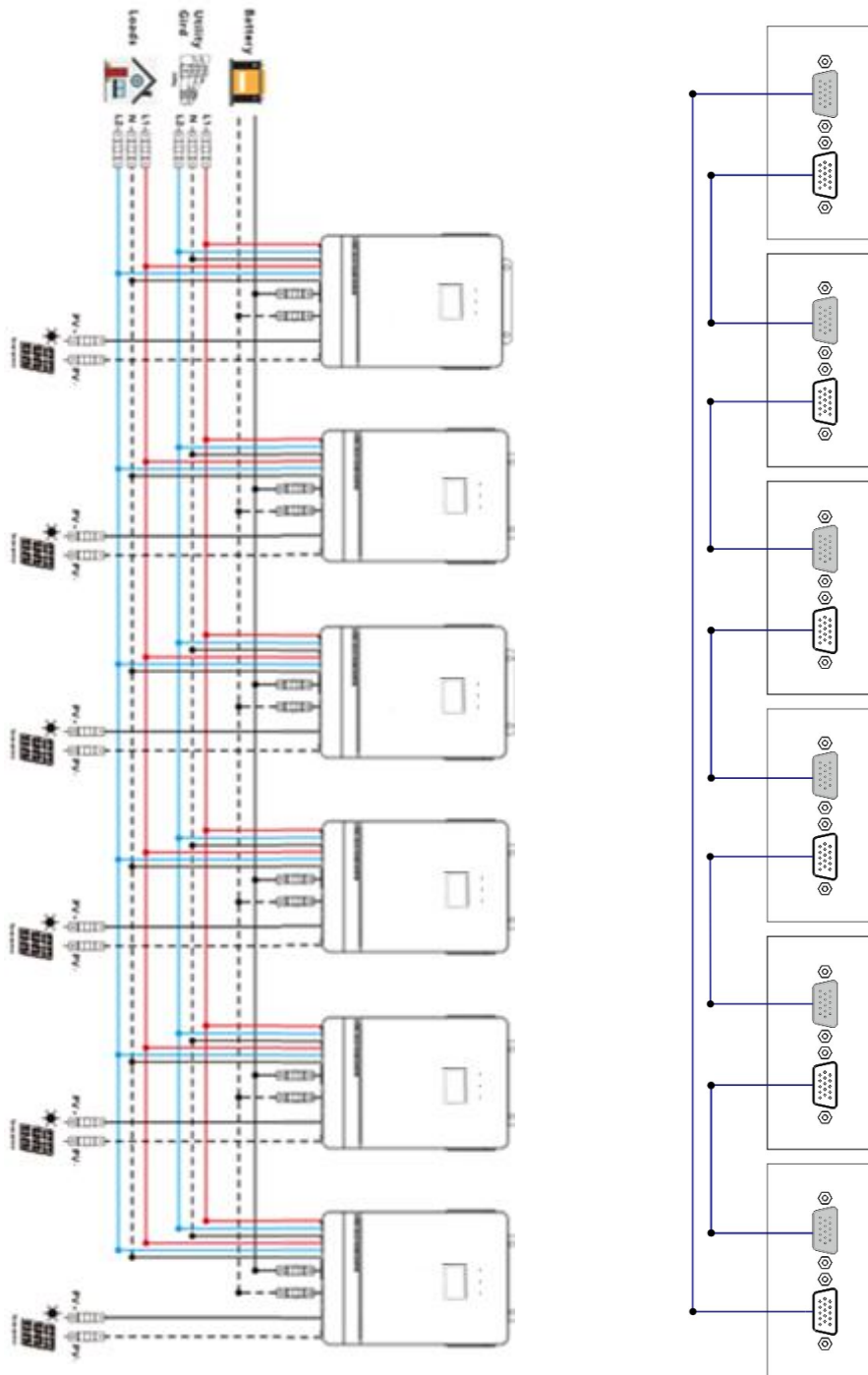

### Parallel Operation in single phase:

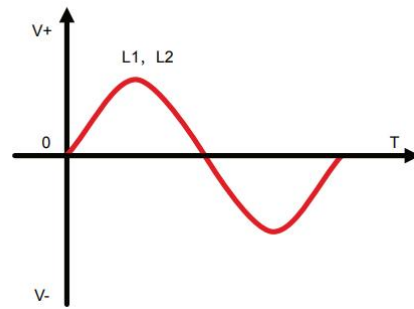
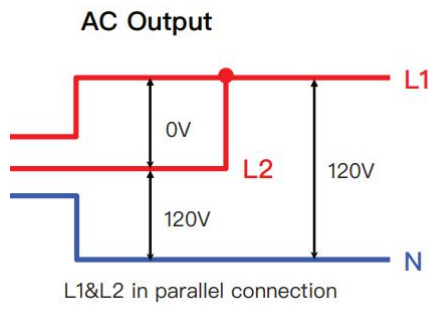

### a) six inverters of the system connected in single phase:

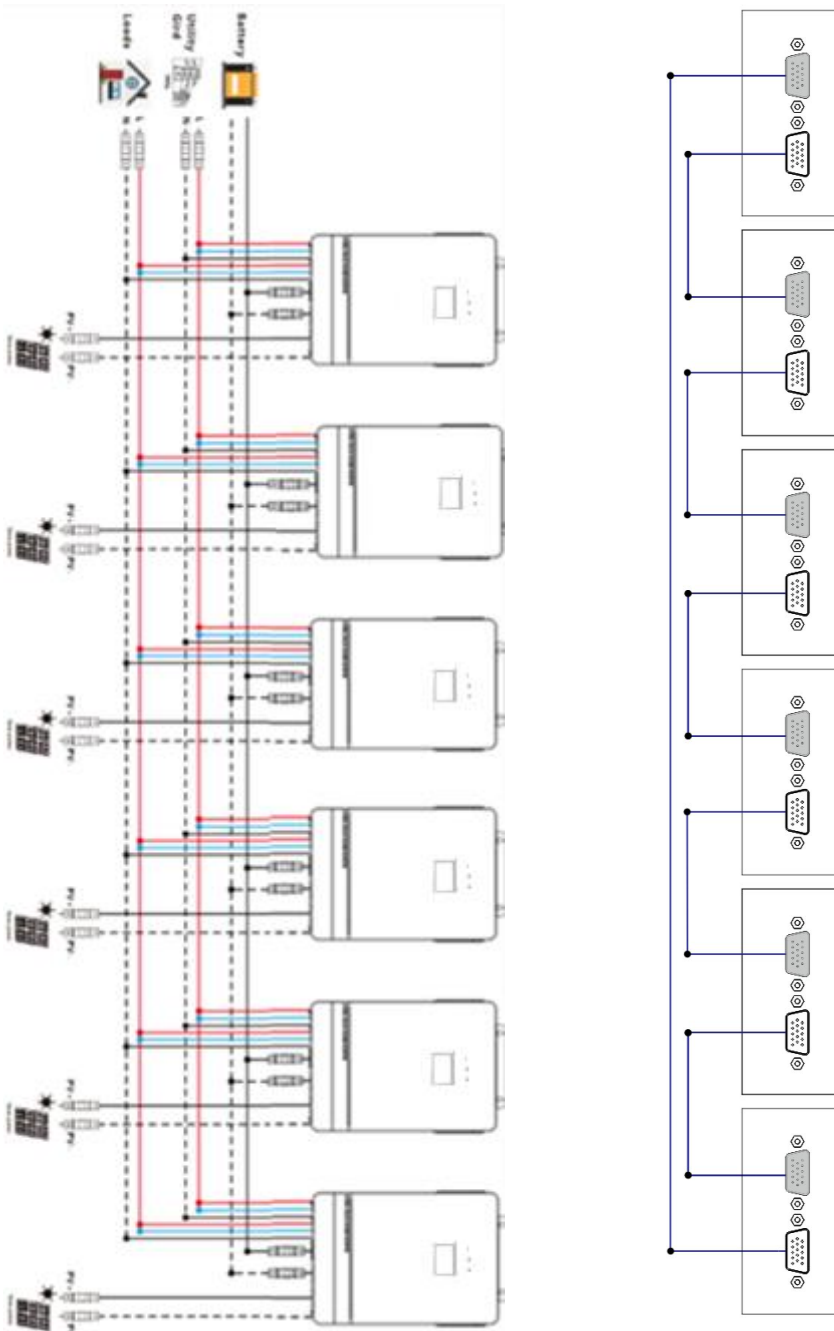

**Note:**

- 1) Before starting up and running, please check whether the connection was correct to avoid any abnormalities in the system.
- 2) All wiring must be fixed and reliable to avoid wire drop during use.
- 3) When the AC output is wired to the load, it shall be properly wired according to the requirements of the electrical load equipment to avoid damage to the load equipment.
- 4) Settings AC out voltage need to be set consistently or only for the host. When the machine is running, the voltage set by the host shall prevail, and the master will force the rewrite of the other slave machines to keep the same set. Only can be set in the standby mode.

AC output voltage setting	120Vac <b>default</b>	Allow to set to 100Vac/105Vac/110Vac/120Vac/127Vac, default 120V. The rated output power will be reduced= $(\text{Power Rate}) \times (\text{Vset}/120)$
---------------------------	-----------------------	--

- 5) When using parallel or split phase separation function, the setting items need to be set accordingly.

AC output phase setting	Single phase	Stands for single-phase mode. The phase same of L1-L2 is 0 degree, L1/L2 in parallel connection. As AC output voltage setting was 120Vac, therefore L1-N/L2-N voltage was 120Vac, L1-L2 voltage was 0Vac. Setting allowed only when output is switched off.
	Split 120	Stands for split-phase mode. The phase difference of L1-L2 is 120 degree, L1/L2 in split connection. As AC output voltage setting was 120Vac, therefore L1-N/L2-N voltage was 120Vac, L1-L2 voltage was 208Vac. Setting allowed only when output is switched off.
	Split 180	Stands for split-phase mode. The phase difference of L1-L2 is 180 degree, L1/L2 in split connection. As AC output voltage setting was 120Vac, therefore L1-N/L2-N voltage was 120Vac, L1-L2 voltage was 240Vac. Setting allowed only when output is switched off.

- 6) When the phase sequence is set on the screen, the setting one is turned on to set, and the other machines are turned off. One by one set. Finally, power off and start up again.
- 7) After the system runs, the output voltage is measured correctly, and then the load setting is connected.

## 9. Failure codes and countermeasures

### 9.1. Fault code

<b>Fault code</b>	<b>Fault name</b>	<b>Whether it affects the output or not</b>	<b>Description</b>
<b>【01】</b>	Battery under voltage warning	No	If the battery voltage is lower than "battery under voltage alarm" setting, the battery was in the undervoltage state.
<b>【02】</b>	Battery under voltage protection	Yes	When the battery voltage was low, turn off the output to stop the battery discharge protection.
<b>【03】</b>	Average battery discharge current over current protection	Yes	If the average battery discharge current exceeds the maximum input battery current for 1 minute, turn off the output to stop the battery discharge protection.
<b>【04】</b>	Instantaneous battery discharge over current protection	Yes	If the instantaneous value of the battery discharge current is greater than the maximum instantaneous value of the device, turn off the output to stop the battery discharge protection.
<b>【05】</b>	Battery not connected	Yes	Battery not connected warning.
<b>【06】</b>	Battery over voltage	Yes	When the selected battery type or set battery voltage is exceeded, turn off the output to stop the battery charging protection.
<b>【07】</b>	BMS low battery talarm	No	BMS alarm low battery (Set BMS enablement to work)
<b>【08】</b>	BMS low battery protection	Yes	The BMS battery capacity rate is low. Disable the output to stop the battery discharge protection. (Set BMS enablement to work)
<b>【09】</b>	Bypass overload protection	Yes	If the mains is overloaded, turn off the AC output and stop the mains charging.

<b>【10】</b>	Battery output overload protection	Yes	If the battery discharge inverter is overloaded, turn off AC output and stop battery discharge protection.
<b>【11】</b>	Battery inverter output short circuit	Yes	If the AC output of the battery inverter discharge is short circuiting, turn off the AC output and stop the battery discharge protection.
<b>【12】</b>	The AC output of the battery inverter over circuit	Yes	If the AC output of the battery inverter discharge is over circuit, turn off the AC output and stop the battery discharge protection.
<b>【13】</b>	The DC component of the battery inverter voltage is abnormal	Yes	If the DC component of the battery inverter voltage is abnormal, turn off the AC output and stop the battery discharge protection.
<b>【14】</b>	Bus over voltage software sampling protection	Yes	Internal battery boost, boost bus voltage overvoltage software protection, turn off AC output and charge.
<b>【15】</b>	Bus over voltage hardware sampling protection	Yes	Internal battery boost, boost bus voltage overvoltage hardware protection, turn off AC output output and charge.
<b>【16】</b>	Bus under voltage protection	Yes	Internal battery boost, boost bus voltage undervoltage protection, turn off AC output output and charge.
<b>【17】</b>	Bus short circuit protection	Yes	Internal battery boost, boost bus voltage short-circuit protection, turn off AC output output and charge.
<b>【18】</b>	The PV input voltage is over voltage	Yes	The solar input voltage exceeds the maximum allowable input voltage protection.
<b>【19】</b>	PV Over Curr Sw	Yes	Solar charging overcurrent software protection, turn off solar charging.
<b>【20】</b>	PV over curr Hw	No	Solar charging overcurrent hardware protection, turn off solar charging.
<b>【21】</b>	PV Iso Low	Yes	The PV insulation impedance is low, and the inverter is shutdown.

<b>【22】</b>	The PV heat sink is overheated. Procedure	No	If the temperature of the solar charging radiator is too high, turn off the solar charging.
<b>【23】</b>	The AC heat sink is overheated. Procedure	Yes	If the temperature of the heat sink is too high, turn off the AC charging or battery inverter discharge.
<b>【24】</b>	The temperature of the main transformer is overheated	Yes	If the internal main transformer temperature is too high, turn off the AC charging or battery inverter discharge.
<b>【25】</b>	<b>Ac input</b> relay short circuit	Yes	Ac input relay short-circuit protection prevents the inverter AC output from being pumped back into the bypass AC input,the inverter is turned off.
<b>【26】</b>	Output relay short	Yes	Output relay short circuit,
<b>【27】</b>	Fan failure	Yes	If the fan is blocked or fails, disable the inverter output and charging functions.
<b>【28】</b>	EEPROM	Yes	The program is not activated.
<b>【29】</b>	SPI Comm Err	Yes	Master chip and from the chip communication error.
<b>【30】</b>	Type detectionerror	Yes	The model is not set before delivery, and the model identification is wrong.
<b>【31】</b>	Bus Soft Start Fail	Yes	Inverter busbar soft start failed.
<b>【32】</b>	LeakageCurr Over	Yes	The leakage current sensor has a sampling exception.
<b>【33】</b>	Parallel control can communication is faulty	Yes	In parallel mode, CAN communication is lost, AC output and charging are turned off.
<b>【34】</b>	Parallel control can communication is faulty	Yes	In parallel mode, CAN communication is lost, AC output and charging are turned off.
<b>【35】</b>	Parallel mode is faulty	Yes	In parallel mode, the system has inconsistent machine parallel mode <b>【31】</b> Settings.
<b>【36】</b>	Parallel current sharing fault	Yes	In parallel mode, the AC output of the battery inverter differs greatly from the non-uniform current output of each machine. Turn off the AC output and charge.

<b>【37】</b>	Parallel ID setting error	Yes	In parallel mode, the RS485 addresses repeatedly conflict. The fault stops the AC output and charge. After the host automatically reallocates the address, the fault is cleared and the host enters the parallel.
<b>【38】</b>	Inconsistent Battery in parallel mode	Yes	In parallel mode, the battery voltage input of each machine varies greatly.
<b>【39】</b>	Inconsistent AC input source in parallel mode	Yes	Inconsistent AC input source in parallel mode
<b>【40】</b>	The parallel mode synchronization fails	Yes	Parallel mode, hardware synchronization signal reception failure, stop parallel and AC output.
<b>【41】</b>	Inconsistent system firmware version in parallel mode	Yes	If the program version is inconsistent in the parallel system, stop the parallel and AC output.
<b>【42】</b>	The parallel communication cable is faulty	Yes	The parallel communication line is faulty. Stop the parallel and AC output.
<b>【43】</b>	Serial number error	Yes	The serial number is not set before the factory, or the factory serial number is set repeatedly in the system.
<b>【49】</b>	BMS communication error	No	Check whether the communication line is connected correctly and whether <b>BMS</b> is set to the corresponding lithium battery communication protocol
<b>【50】</b>	BMS other alarm	No	Check the BMS fault type and troubleshoot lithium battery problems
<b>【51】</b>	BMS battery over temperature alarm	No	BMS alarm lithium battery over temperature
<b>【52】</b>	BMS battery over current alarm	No	BMS alarm lithium battery over current
<b>【53】</b>	BMS battery over voltage alarm	No	BMS alarm lithium battery over voltage
<b>【54】</b>	BMS battery low voltage alarm	No	BMS alarm lithium battery low voltage

<b>【55】</b>	BMS battery low temperature alarm	No	BMS alarm lithium battery low temperature
-------------	-----------------------------------	----	---

## 9.2、 Trouble Shooting

<b>Fault code</b>	<b>Faults</b>	<b>Handling measures</b>
/	No display on the screen	Check if the battery air switch or the PV air switch has been closed; if the switch is in the "ON" state; press any button on the screen to exit the screen sleep mode.
<b>【06】</b>	Rechargeable battery overvoltage protection	Measure if the battery voltage exceeds rated. If it exceeds, the battery needs to be discharged until the voltage is below the overvoltage recovery point of the battery.
<b>【01】 【02】</b>	Battery under voltage protection	Charge the battery until it returns to the low voltage disconnection recovery voltage.
<b>【27】</b>	Fan failure	Check if the fan is not turning or blocked by foreign object.
<b>【22】 【23】</b>	Heat sink over temperature protection	When the temperature of the device is cooled below the recovery temperature, normal charge and discharge control is resumed.
<b>【09】 【10】</b>	Bypass overload protection, inverter overload protection	1.Reduce the use of power equipment; 2.Restart the unit to resume load output.
<b>【11】</b>	Inverter short circuit protection	1.Check the load connection carefully and clear the short-circuit fault points; 2.Re-power up to resume load output.
<b>【18】</b>	PV overvoltage	Use a multimeter to check if the PV input voltage exceeds the maximum allowable input voltage rated.
<b>【05】</b>	Battery missed alarm	Check if the battery is not connected or if the battery circuit breaker is not closed.
<b>【40】 【42】</b>	Parallel connection fault	Check whether the parallel line is not connected well, such as loose or wrong connection.
<b>【37】</b>	Parallel ID setting error	Check whether the setting of parallel ID number is repeated.
<b>【36】</b>	Parallel current sharing fault	Check whether the parallel current sharing line is not connected well, such as loose or wrong connection.

<b>【39】</b>	Inconsistent AC input source in parallel mode	<p>Check whether the parallel AC inputs are from the same input interface.</p> <p>If two of the three phases report that the mains input sources are inconsistent in the three-phase mode, you can try to swap the mains input wiring of any two machines to check whether the mains input phase sequence is inconsistent with the set phase sequence.</p>
<b>【41】</b>	Inconsistent system firmware version in parallel mode	<p>Check whether the software version of each inverter is consistent.</p>

**Note:** If you encounter a product fault that cannot be solved by the methods in the above table, please contact our after-sales service department for technical support, and do not disassemble the equipment yourself.

# 10. Protection and Maintenance

## 10.1. Protections provided

No.	Protections	Description
1	PV current/ power limiting protection	When charging current or power of the PV array configured exceeds the PV rated, it will charge at the rated.
2	PV night reverse-current protection	At night, the battery is prevented from discharging through the PV module because the battery voltage is greater than the voltage of PV module.
3	Mains input over voltage protection	When the mains voltage exceeds 140V, the mains charging will be stopped and switched to the inverter mode.
4	Mains input under voltage protection	When the mains voltage is lower than or 85V , the mains charging will be stopped and switched to the inverter mode.
5	Battery over voltage protection	When the battery voltage reaches the overvoltage disconnection point, the PV and the mains will be automatically stopped to charge the battery to prevent the battery from being overcharged and damaged.
6	Battery low voltage protection	When the battery voltage reaches the low voltage disconnection point, the battery discharging will be automatically stopped to prevent the battery from being over-discharged and damaged.
7	Load output short circuit protection	When a short circuit fault occurs at the load output terminal for more than 200 milliseconds, the AC output is immediately turned off.
8	Heat sink over temperature protection	When the internal temperature is too high, the all-in-one machine will stop charging and discharging; when the temperature returns to normal, charging and discharging will resume.
9	Overload protection	Output again 3 minutes after an overload protection, and turn the output off after 5 consecutive times of overload protection until the machine is re-powered. For the specific overload level and duration, refer to the technical parameters table in the manual.

10	PV reverse polarity protection	When the PV polarity is reversed, the machine will not be damaged.
11	AC reverse protection	Prevent battery inverter AC current from being reversely input to Bypass.
12	Bypass over current protection	Built-in AC input overcurrent protection circuit breaker.
13	Battery input over current protection	When the discharge output current of the battery is greater than the maximum value and lasts for 1 minute, the AC input would switched to load.
14	Battery input protection	When the battery is reversely connected or the inverter is short-circuited, the battery input fuse in the inverter will blow out to prevent the battery from being damaged or causing a fire.
15	Charge short protection	When the external battery port is short-circuited in the PV or AC charging state, the inverter will protect and stop the output current.
16	CAN communication loss protection	In parallel operation, an alarm will be given when CAN communication is lost.
17	Parallel connection error protection	In parallel operation, the equipment will be protected when the parallel line is lost.
18	Parallel battery voltage difference protection	In parallel operation, the equipment will be protected when the battery connection is inconsistent and the battery voltage is greatly different from that detected by the host.
19	Parallel AC voltage difference protection	In parallel operation, the equipment will be protected when the AC IN input connection is inconsistent.
20	Parallel current sharing fault protection	In parallel operation, the running equipment will be protected when the load difference of each inverter is large due to improper connection of current sharing line or device damage.
21	Synchronization signal fault protection	The equipment will be protected when there is a fault in the guidance signal between parallel buses, causing inconsistent behavior of each inverter.

## 10.2. Maintenance

1. In order to maintain the best long-term performance, it is recommended to conduct following checks twice a year.
2. Make sure that the airflow around the unit is not blocked and remove any dirt or debris from the heat sink.
3. Check that all exposed wires are damaged by exposure to sunlight, friction with other objects around them, dryness, bite by insects or rodents, etc., and the wires shall be repaired or replaced if necessary.
4. Verify for the consistency of indication and display with the operation of the device. Please pay attention to the display of any faults or errors, and take corrective actions if necessary.
5. Check all wiring terminals for corrosion, insulation damage, signs of high temperature or burning/discoloration, and tighten the screws.
6. Check for dirt, nesting insects and corrosion, and clean up as required.
7. If the arrester has failed, replace in time to prevent lightning damage to the unit or even other equipment of the user.

**The company does not assume any liability for damage caused by:**



**NOTICE**

- a) Improper use or use in improper site.
- b) Open circuit voltage of the PV module exceeds the maximum allowable voltage rated.
- c) Temperature in the operating environment exceeds the limited operating temperature range.
- d) Disassemble and repair the all-in-one solar charge inverter without permission.
- e) Force majeure: Damage that occurs in transportation or handling of the all-in-one solar charge inverter.

**DANGER**

**Danger of electric shock! When doing the above operations, make sure that all power supplies of the all-in-one machine have been disconnected, and all capacitors have been discharged, and then check or operate accordingly!**

# 11. Technical parameters

Models	AS103048-M200-B	AS103048-M200-A	AS123048-M220-B	AS123048-M220-A
<b>Parallel mode</b>				
Permitted parallel number	1~6	NO	1~6	NO
<b>AC mode</b>				
Rated input voltage	120(L1/N, L2/N)/240Vac(L1/L2)			
Input phase voltage range	(85Vac~140Vac)±2%			
Frequency	50Hz/60Hz (Auto detection)			
Frequency Range	47±0.3Hz~55±0.3Hz (50Hz); 57±0.3Hz~65±0.3Hz (60Hz);			
Overload/short circuit protection	Circuit breaker			
Efficiency	>95%			
Conversion time (bypass and inverter)	10ms (typical)			
AC reverse protection	Yes			
Maximum bypass phase overload current	2pole, 60A/60A(L1/L2)			
<b>Inverter mode</b>				
Output voltage waveform	Pure sine wave			
Rated output power (VA)	Split phase: 10000		Split phase: 12000	
	Single phase: 7200 (limited by the wiring terminals)		Single phase: 7200 (limited by the wiring terminals)	
Rated output power (W)	Split phase: 10000		Split phase: 12000	
	Single phase: 7200 (limited by the wiring terminals)		Single phase: 7200 (limited by the wiring terminals)	
Power factor	1			
Rated output voltage (Vac)	120Vac (L1/N, L2/N)/240Vac(L1/L2)			
Output voltage error	±5%			
Output frequency range (Hz)	50Hz±0.3Hz/60Hz±0.3Hz			

Maximum Efficiency	>91%	
Overload protection	(105% < load < 110%) ±5%: report error and turn off the output after 5 minutes; (110% < load < 125%) ± 5%: report error and turn off the output after 10 seconds; Load > 125% ±5%: report error and turn off the output after 5 seconds;	
Peak power	Split phase: 15000VA	Split phase: 18000VA
	Single phase: 15000VA	Single phase: 18000VA
Loaded motor capability	5HP	6HP
Output short circuit protection	Can protect, after continuous short circuit for 1 second	
Bypass circuit breaker phase specification	2pole, 63A/63A(L1/L2)	
Rated battery input voltage	51.2V (Minimum starting voltage 44V)	
Battery voltage range	40.0Vdc~58.6Vdc±0.6Vdc (Undervoltage alarm/shutdown voltage/overvoltage alarm /overvoltage recovery... settable on LCD screen)	
Power saving mode self-consumption	Load per phase is null or less than 25W enter power-saving mode	
<b>AC charging</b>		
Battery type	Lead acid or lithium battery	
Maximum charge current(can be set)	120A	160A
Charge current error	±5A <sub>dc</sub>	
Charge voltage range	40 –58.6Vdc	
Short circuit protection	Circuit breaker and blown fuse	
Circuit breaker phase specifications	2pole, 60A/60A(L1/L2)	
<b>PV charging</b>		
Number of MPPT groups	2	
Maximum PV open circuit voltage	500Vdc	

PV operating voltage range	90Vdc~485Vdc	
MPPT voltage range	90Vdc~450Vdc	
Battery voltage range	40-58.6Vdc	
Maximum PV input power	5500W+5500W	6000W+6000W
Maximum PV input current	22A+22A	
PV charge current(can be set)	200A	220A
Charging short circuit protection	Blown fuse	
Wiring protection	Reverse polarity protection	
<b>Hybrid charging Max charger current specifications (AC charger+PV charger)</b>		
Max charger current(can be set)	0-200A	0-220A
<b>Certified specifications</b>		
Certification	UL1741	
EMC certification level	FCC part15, CLASS B	
Operating temperature range	-10°C to 55°C(>45°C derating)	
Storage temperature range	-25°C ~ 60°C	
Humidity range	5% to 95% (Conformal coating protection)	
Noise	≤60dB	
Heat dissipation	Forced air cooling, variable speed of fan	
Communication interface	USB/RS485(/WiFi/GPRS)/ Dry node control	
Size (L*W*D)	620mm*450mm*132mm	
Weight (kg)	23.8	





